



advice series

roofs

A GUIDE TO THE REPAIR OF HISTORIC ROOFS

roofs

A GUIDE TO THE REPAIR OF HISTORIC ROOFS



Comhshaol, Oidhreacht agus Rialtas Áitiúil
Environment, Heritage and Local Government



Contents

INTRODUCTION	5
1. A BRIEF HISTORY OF IRISH ROOFS	7
The earliest roofs	7
Eighteenth-century roofs	8
Nineteenth-century roofs	8
The twentieth century to today	9
2. ROOF STRUCTURES AND MATERIALS	13
Roof profile	13
Traditional roof forms	14
Structural elements	15
Roof details	20
Roof features	22
3. CLADDING MATERIALS AND METHODS	27
Slate	27
Slating methods	32
Stone slab	34
Clay tile	35
Lead	36
Copper	37
Corrugated iron	39
Other roofing materials	39
4. IDENTIFYING AND ASSESSING PROBLEMS IN ROOFS	45
Routine maintenance	46
Inspection and survey	46
Identifying defects	48
Timber decay	49
Problems arising from inappropriate previous repairs	54
Problems associated with nailing	55
Slate decay	56
Faults from the use of incorrect sheet sizes	56
Insufficient ventilation	56

5. REPAIRING A HISTORIC ROOF	59
Timber structural elements	59
Roof details	61
Rainwater goods	70
Slate repair	73
Stone slab repair	83
Clay tile repair	85
Concrete tile repair	87
Lead and leadwork repair	88
Copper sheet repair	94
Zinc sheet repair	95
Re-roofing flat roofs	96
Corrugated iron repair	96
6. NEW MATERIALS AND TECHNOLOGIES	99
The use of artificial 'slate'	99
Issues arising from the installation of vapour barriers	100
Ventilation and insulation	100
Fire safety measures	102
Lightning conductors	102
GLOSSARY	105

Introduction

The roof is the first line of defence between any building and the elements, and a good working roof is crucial to the survival of a historic building. However, despite its importance, a roof can often be the most neglected part of a building. Roofs are often difficult and dangerous to access. This is particularly the case with tall buildings or those located in terraced streetscapes. Many owners never make it to roof level to carry out even the most basic maintenance inspections of the roof fabric and rainwater drainage system.

This booklet explores the origins and characteristics of the traditional Irish roof, how these roofs were constructed and clad, the qualities of the various materials used and how the form and appearance of the roofs evolved. It deals with the types of defects that are likely to emerge in historic roofs, how to recognise these defects and how to choose the right repair method. This booklet does not offer comprehensive technical advice. Nor does it provide advice on the health and safety issues which arise in the repair, maintenance and conservation of historic roofs.

As the majority of the surviving historic roofs in this country are of timber-framed construction with slate cladding, the booklet concentrates on the characteristics of this roof type, found on a range of buildings, from vernacular buildings to churches and country houses, including the buildings that make up the majority of the built fabric of our cities and towns. Other traditional roofing materials discussed include clay tiles, stone slabs, timber shingles and a variety of metal sheeting types such as lead, copper, zinc and corrugated iron. Thatched roofs are dealt with in a separate publication in this Advice Series: *Thatch – a guide to the repair of thatched roofs*.

Aesthetically, slate roofs make a significant contribution to our built environment. They provide a distinctive character, profile and scale to the structures they cover. A panoramic view of any historic Irish town is characterised by the linear forms and rhythms of gable-ended or hipped slate-clad roofs with their chimneystacks and clay pots, stepping up and down to follow the local topography. The shape of a traditional roof is determined not only by the structural capacity of the roof timbers spanning between the walls of the

building, but also by the characteristics of the particular roof covering. The colour of the roof depends on the type of slate or tile chosen, while the chimneystacks may be of exposed stone or brick or with a rendered finish. These materials were chosen for their availability, their resistance to prevailing weather conditions and also in response to changing architectural styles.

With the widespread use of imported slate over the past two hundred years, it can often be overlooked that Ireland had its own extensive slate and stone quarries and, in many parts of the country, roofs with intact native slate and stone coverings can still be found. These increasingly rare survivors have a particular architectural, cultural and social value and give a distinctive local character to the areas in which they were used. In the past, local craftsmen and labourers went to great effort to extract and deliver these materials for construction. Builders realised the importance of the roof in safeguarding the interior of the building and used the best available materials they could afford in its construction. Roof slates have a distinct and pleasing appearance as well as a robust character, and merit well-considered repair and retention. Welsh slate, the well-known 'Blue Bangor' being only one variety, came to dominate the Irish roofing industry in the nineteenth and twentieth centuries; it is a high-quality, readily available and long-lasting slate. Other significant historic roofing materials include clay tiles, which were fashionable several decades either side of 1900, corrugated iron, lead and copper sheeting.



Irish roofs take many forms; the style and choice of materials used were influenced not only by the available materials, but also by architectural fashion

1. A Brief History of Irish Roofs

The earliest roofs

The roofing tradition in Ireland is quite diverse and a range of materials was employed to construct and cover roofs. Archaeological evidence suggests that the earliest roofs used rough timbers, even branches, covered with a variety of locally available materials such as thatch and sod. However, because of the ephemeral nature of the building materials, these roofs have not survived. The earliest surviving roofs are those of high-quality buildings such as ecclesiastical buildings, civic structures and the houses of the landed classes, including the remarkable stone corbelled roofs of early medieval buildings such as the Gallerus Oratory, County Kerry and Saint Kevin's Kitchen, Glendalough, County Wicklow. These roofs were created by corbelling, that is, course after course of stone stepped inwards gradually until they met to form an apex over the centre of the building, creating a steep pitch externally that efficiently disposed of rainwater. This form of stone technology was still being used in the late-eighteenth and early-nineteenth centuries, as seen in the rare stone farm huts of the Lecale Peninsula, County Down.



Saint Kevin's Church, Glendalough, County Wicklow. The steeply pitched roof of local stone was built up by corbelling and is supported on walls almost 4 feet (1.2m) thick

The structure and form of roofs, and the materials with which they were built, changed over the centuries in response both to developing construction technology and architectural fashion. Medieval tower houses were generally constructed with thick masonry walls supporting heavy oak-beamed roofs. The roofs of tower houses were typically concealed behind stepped parapets, with wall walks, from which rainwater was thrown clear via projecting gargoyles or stone spouts. Evidence of roofing materials used during this period may be found in contemporary written sources or discovered through archaeological investigation.

The period of relative peace following the Cromwellian wars led to the development of very different, less defensive, houses in the latter half of the seventeenth century. Under the influence of the architectural ideas of the Renaissance, the form of the roof came to be seen as integral to the overall composition. Roof dormers became common and were designed to read as part of the fenestration pattern of the entire façade. On more substantial structures, the roof profile was enhanced by decorative corbels and pedimented gable fronts. Seventeenth-century roof profiles tended to be steeply pitched to ensure a fast flow of water off the small slate or tile cover. Plain (flat) and double-curved clay tiles, or 'pantiles', were commonly used. The use of slate at this time was limited to prestigious buildings.



Tower houses were heavily fortified, with their roofs concealed behind battlements. In contrast, the architecture of the sixteenth and seventeenth centuries brought the roofscape increasingly into full view. At Ormond Castle, County Tipperary, the remains of the earlier tower house can be seen rising behind the Elizabethan mansion with its then highly fashionable dormer gables

Rainwater goods of the more substantial or urban houses of the late-seventeenth and early-eighteenth centuries were generally made of lead, with lead-lined outlets through parapets or from eaves connecting to lead hopper heads and downpipes. However, there was a general lack of understanding of lead's tendency to expand in heat and to tear when this expansion was restricted, or when the lead was used in sheets that were too long or too wide.

Most vernacular roofs of this period were designed to throw rainwater directly off the roof with no separate drainage system. The stone slab, or flag, roofs found in the west of Ireland demonstrate the use of local stone to protect simple vernacular buildings against severe weather conditions.

Eighteenth-century roofs

Slate, which had been imported from Wales since medieval times, became increasingly popular in the eighteenth century. By 1778, the Reverend Thomas Campbell, in *A Philosophical Survey of the South of Ireland*, commented on the *blue slating having a finer effect than you can imagine* when seen in views across the city from the steeples of Dublin. Welsh slate, with its typical blue-grey and purple colouring, is the most predominant surviving roofing material from the period, although some very beautiful examples of Irish slate still survive in situ from this time. Slate has distinguishing characteristics depending on the geological seam from which it is quarried. Hand-extracted slate looks substantially different to the more regular, machine-harvested slate produced today. Original eighteenth-century slate roofs are rare survivors, recognisable by the small, irregularly shaped sizes of the hand-dressed slate. As the century progressed, the use of clay tile as a roofing material gradually died out.

Because of the increasing interest in classical architecture from the early-eighteenth century onwards, the typical Georgian roof was designed to be concealed behind masonry parapets to avoid disrupting the proportions of the main façade. This led to the use of shallower pitches and double roofs, all with the aim of making the roofline lower and less visible. The use of dormer windows to the front slope of the roof largely disappeared from Dublin buildings as the century progressed, although their use lingered on in other areas.



The typical Georgian streetscape of the late-eighteenth century is characterised by the suppression of the roof as an architectural element. Roof pitches were reduced to a minimum and architectural devices such as double roofs and parapet walls were used to ensure that the roof stayed out of sight from street level

Nineteenth-century roofs

In the nineteenth century, the improved output of Irish quarries and the vastly increased supply of affordable, machine-manufactured slate from Wales facilitated the extensive use of slate as a roof covering, particularly in areas accessible by sea or canal. These Welsh slates were generally of large size, were smoothly dressed and had more intense colour hues than the smaller slates quarried in the eighteenth century. The introduction of large slates allowed roofs of lower pitch to be constructed. These roofs performed differently to their predecessors as the increased overlap between the larger slates afforded greater watertightness. 'Gauged' roofs, or roofs using decreasing slate sizes from eaves to ridge, became popular, as did slates shaped in fishscale or scalloped patterns and slates laid on the diagonal to create a decorative geometrical effect. Colour was also employed; polychromatic roofs used two or more colours of slate in contrasting courses or patterns. The Victorian taste was for complex and distinctive roofs,

in comparison with the simple, understated roofs of the Georgian and late-Georgian periods. Later nineteenth-century roofs came to be embellished with decorative ridge tiles, ornate chimneypots or dormers framed by carved timber bargeboards – a combination of these elements lent a fashionable Tudor or Gothic Revival character to a building. Parapet gutters, or cast-iron gutters on driven-in brackets, draining to cast-iron hopper heads and vertical downpipes, were used to collect rainwater and drain it away from the building.



Victorian roofs are often architecturally complex, using a variety of roof shapes, roofing materials and embellishments

The use of clay roof tiles was revived in the latter decades of the nineteenth century as part of the Arts and Crafts style of architecture. New roof forms were explored and new roof elements introduced. Coloured, moulded and glazed clay tiles were increasingly used for finials, copings, corbels, turrets and pantiled roofing. The embellishment of roof features extended to rainwater goods and decorative ironwork, with larger, more visible details such as large box hopper heads with embossed insignia and square-profile downpipes held by decorative clasps, painted to coordinate or to contrast with the building.



The nineteenth century saw a resurgence in the use of terracotta tiles as part of a revived interest in handmade building materials. Clay tiles allowed the introduction of colour and decoration at roof level, creating a whole new aesthetic

The twentieth century to today

During the twentieth century the use of slate gradually waned, mainly due to its ever-increasing cost and competition from industrially manufactured clay tiles – and later, from concrete and fibre-cement tiles. In areas close to productive quarries the use of slate continued longer. Concrete tiles were made by a number of Irish manufacturers from the 1930s onwards. Many Land Commission and local authority houses were roofed with 'Marley Ludlow' and or 'Anglia' tiles. Flat concrete roofs covered with a waterproof sheeting material were increasingly used on many building types. Primarily for aesthetic reasons, but also due to their poor performance in the Irish climate, they did not generally find favour for dwellings. Rapid and continual technological and structural innovation in the twentieth century encouraged the introduction of new roofing materials, such as metal sheeting products and roofing membranes, in tandem with new roof forms.

The period between 1985 and 2000 saw a revival in the use of natural slate and clay tiles and the importation of new slate varieties from, amongst others, countries such as Spain, France, Canada and Brazil. The fashionable use of natural slate has continued into the new century.

Conservation principles

The primary aim of conservation is to prolong the life of something of value, and to do so in a way that protects what is valuable about it. The built heritage enriches our lives and provides a connection with, and a means of understanding, our shared past. Historic buildings have incalculable value as tangible records of those who have gone before us, of the lives they lived and of their aspirations and achievements. Each structure provides unique and irreplaceable evidence of the past and should be passed on to future generations with that evidence intact.

As each historic building is unique, each requires an individual assessment of its significance, its condition and a solution to the particular conservation issues that have arisen. Building conservation requires highly specialised skills in all aspects of the works. Expert advice is needed in assessing the extent of works required, designing and specifying those works, overseeing the project on site, and skills are required of the craftworkers, stonemasons and others who carry out the works to the building.

An aim of good conservation is that there should be minimum intervention into the historic fabric of a structure. Conservation works should do as much as necessary, yet as little as possible to the structure to ensure its future. This means that elements should be repaired rather than replaced. Conjectural reconstruction of any part of the structure should be avoided and only undertaken where there is good reason and where the works can be based on reliable documentary or other evidence. Appreciation is needed of all the various phases of construction. Later additions or alterations may be of equal, or in some cases more, interest than the original built fabric.

CARRYING OUT MAINTENANCE OR REPAIR WORKS TO ROOFS

- > Do use the experts - get independent advice from the right people, particularly prior to the installation of roof insulation, to ensure that appropriate levels of ventilation are maintained
- > Do record the materials and construction details of the historic roof before altering it
- > Do establish and understand the reasons for failure before undertaking repairs
- > Do repair the parts of the structure that need it - do not replace them unless they can no longer do the job they were designed to do
- > Do make sure the right materials and repair techniques are used and that even the smallest changes made to the structure are done well
- > Do use techniques that can be easily reversed or undone. This allows for any unforeseen problems to be corrected in future without damage to the special qualities of the structure
- > Do establish and understand the reasons for failure before undertaking repairs
- > Do record all repair works for the benefit of future owners

- > Don't overdo it – only do as much work to the structure as is necessary, and as little as possible
- > Don't look at problems in isolation – consider them in the context of the structure as a whole
- > Don't use architectural salvage from elsewhere unless certain that the taking of the materials has not caused the destruction of other old buildings or been the result of theft

Timeline of availability and use of roofing and guttering materials in Ireland

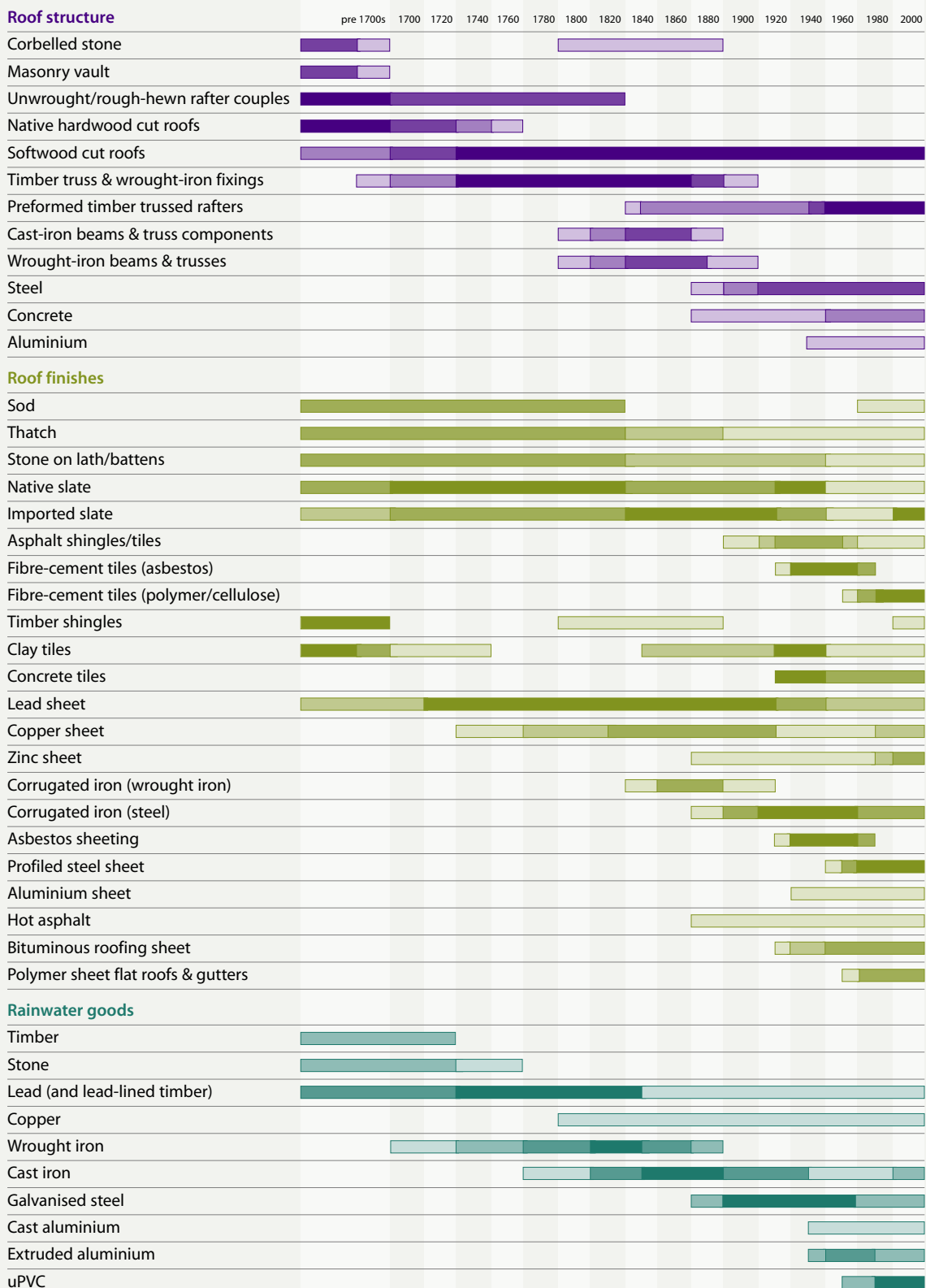

The degree of shading relates to the extent of use of the roofing material: the darkest shading indicates periods when the material was in widespread use while the lightest shading indicates periods when it has been found in use in isolated examples. In the periods where no shading is shown, there is no evidence of use of the material or it was not yet invented.

This table indicates the approximate date of introduction of different roofing materials into Ireland

2. Roof Structures and Materials

The shape and appearance of a traditional roof were determined primarily by the properties of the materials chosen to construct and to clad the roof. However, architectural fashions and styles also played a role and influenced the final roof form. Other important components of the traditional pitched roof – the ridge, the verge and the eaves – could be built and assembled in many ways, giving rise to the myriad of different forms found in Irish roofs.

Roof profile

The capability of the chosen structural material to span between supports dictated not only the shape of the roof, but also the overall depth and dimensions of the building. Traditionally, timber was the most common structural material used in Irish roofs and the shape and proportions of these roofs were based on the span of the timbers between supports, usually load-bearing walls.

The pitch, or slope, of a roof was determined both by the characteristics of the cladding material to be used and by architectural fashion. Different cladding materials are required to be laid at different pitches if they are to provide a watertight roof that will counteract wind pressure and avoid becoming saturated by rainwater. The roof pitch may range from a steep 60 degrees on some seventeenth-century buildings to a shallow 30 degrees or less on eighteenth-century roofs designed to be concealed behind a parapet, but is commonly between 40 – 45 degrees on slate roofs. Clay tile can tolerate being laid at a shallower pitch than slate, as low as 22.5 degrees for interlocking tiles and pantiles. Where stone flags were used the pitch of the roof rarely exceeded 40 degrees. Corrugated iron can be used at very low pitches. Timber shingles, of which few examples survive, were typically used on steep pitches.

The pitch of a roof may also hint at its historical origins; for example, a steeply pitched corrugated-metal roof on a vernacular house suggests that the roof was originally thatched, as thatch must be laid at

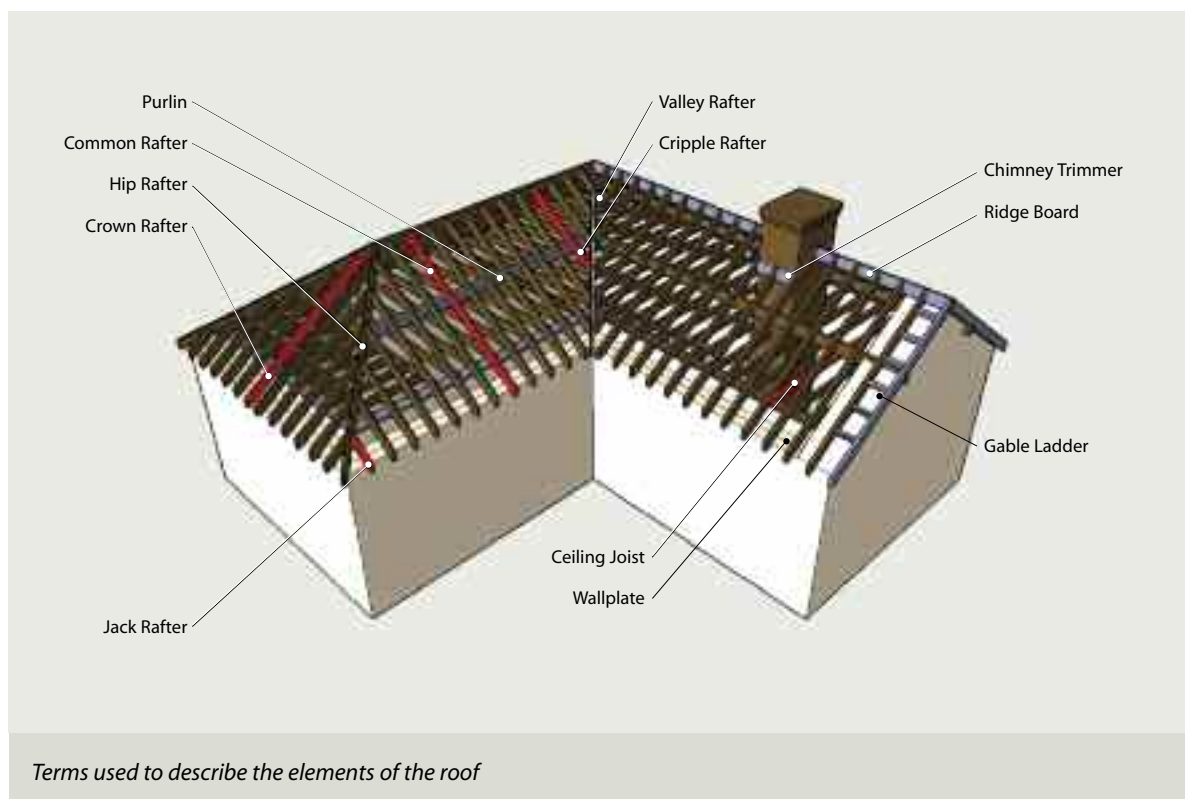

a steep pitch to prevent rainwater soaking into it. In many cases, a thatched roof may still be found beneath the metal covering. Similarly, the position of structural elements such as chimneystacks can provide clues to the date of a structure and to the internal layout of the building. Exposed chimneybreasts projecting from the gable ends of a house may indicate an English influence in the design, while a chimneystack in line with the main entrance of a vernacular dwelling denotes a central hearth protected by a jamb wall.

Pitched roofs splayed in a curve over a projecting bow were usually clad in slate but, where the geometry precluded the use of slate, lead or cut stone were often used. Domes and cupolas, with their steep and curving roofs, were usually clad in copper or lead sheet which could be easily moulded to follow the shape of the roof.

Traditional roof forms

DOUBLE-PITCHED ROOF

The most common form of traditional roof is the double-pitched or 'A-framed' roof. The rafter pairs were usually tied with horizontal tie beams. Ceiling finishes, if applied at all, were fixed directly to the underside of the rafters and tie beams.

Although a simple double pitch is the most common form of roof found, roofs may vary from a single, or mono, pitch to more complex arrangements. In the eighteenth century, the desire to reduce the visual prominence of the roof led to the use of two double-pitched roofs, each with a shallow pitch, forming a double 'A' profile with a central valley, thus reducing the overall span and the height of the roof.

Some typical roof forms

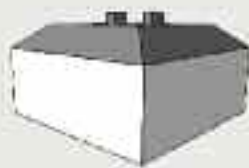

Roof with concealed central valley



Double 'A' roof with central valley



Mansard roof



Hipped roof with mono-pitch to the rear



Roof with gable ends and bow front

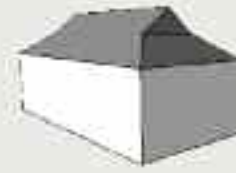

Gambrel roof

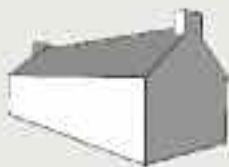

Roof with gable ends

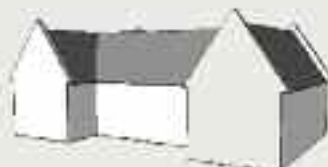

Gothic-style roof



Curved roof



Hipped roof with gabled entrance



Half-hipped roof



Mono-pitch roof

GABLED

A gabled roof is a double-pitched roof finished at each end with a gable wall.

HIPPED, HALF-HIPPED, GAMBREL

There are several variations in hipped roof construction. The most common hipped roof is one where, instead of ending in a gable, the short side of the roof slopes. In a half-hipped roof, only the top portion of the roof slopes, while in a gambrel roof the lower portion slopes and is topped with a small gable or gablet. On hipped roofs, a decorative wrought-iron strap was sometimes fixed to the top of the hip rafter to reduce strain from the weight of the clay hip tiles. Less decorative straps were concealed in the bedding for the ridge stone or hip tile at eaves level.

MANSARD ROOFS

A Mansard roof is a roof which has two pitches to each slope; the lower being steeply pitched and almost vertical, while the upper part has a shallower pitch. Often the lower part contains a series of dormer windows and the shape of the roof allows the full use of the attic space for accommodation. The name comes from the French architect, François Mansart, who popularised the use of roofs of this shape in the seventeenth century.

Structural elements

TIMBER IN IRISH ROOFS

The roof cladding was laid on a structure of timber, usually made from rough-hewn, hand-sawn or, from the mid-nineteenth century onwards, machined timbers. Oak was Ireland's first preference for building timber and is found in the few surviving roofs from the medieval period and in several early eighteenth-century roofs. However, as charcoal production depleted the forests, oak suitable for construction became increasingly difficult to obtain. From as early as the first quarter of the seventeenth century, timber for building was imported and from the early eighteenth century onwards Ireland relied heavily on imported timber for construction. This had

consequences for structural and joinery details: for example, disruptions in the supply of timber during the Napoleonic wars may have influenced changes in joinery details in the late-Georgian terrace houses of Dublin; the harsh economic conditions at the time of the Great Famine may have been the reason for the use of undersized roof timbers found in some structures of the mid-nineteenth century.

Timber imported into Ireland in the seventeenth century was generally supplied from Norway. From the first quarter of the eighteenth century, it was also imported from Sweden and the Baltic coasts of Poland, Germany and Russia.



An eighteenth-century re-roofing of a tower house using imported deal

Northern pine or Scots Pine (*Pinus Sylvestris*) was the most common import. It is a pale yellow wood with red annular rings. When cut in planks it was historically known in the timber trade as 'red deal'. Although still frequently referred to as red deal in the trade, its modern name is European redwood. Since it came from mature, slow-grown trees, this timber contained a large percentage of resinous heartwood and has proved very durable. Its durability and availability in long lengths made it particularly suitable for use as beams, joists, and roof rafters.

Norway spruce (*Picea Abies*) is white to pale beige in colour with a fine regular grain. Once known as 'white deal', the timber is today also referred to as European whitewood and is commonly sold for structural use. As it is neither as strong nor as durable as red deal, it should not be used in repair work to historic roofs except as sarking or decking.

TRADITIONAL ROOF CONSTRUCTION

In the earliest and simplest buildings, the roof structure consisted of unwrought rafters in pairs coupled together at their apex. The lower ends of the rafters were set directly onto the wall top. These rafters were frequently of small size and unevenly spaced. Usually a collar tie was fixed at mid-rafter span or slightly higher.



Halved wall plate plus timber strap bedded into a cross wall



Undersized, long-spanning ceiling joists in this late eighteenth-century roof have become overloaded with pieces of fallen parging and pigeon guano, leading to deflection of the joists

Traditional roof construction evolved to commence with the laying of a sawn timber wall plate along the wall tops to provide a good horizontal bed off which to build the roof. This wall plate was usually, but not always, located at the inner face of the wall and also served to distribute the weight of the roof evenly along the wall. To achieve a continuous and secure

wall plate, lengths of timber were scarf jointed and bedded in lime mortar and were frequently secured with timber ties or wrought-iron strapping.

Sawn timbers were then laid in couples connected to each other at their apex and, from the early-eighteenth century onwards, to a timber ridge board. These timbers, running from wall plate to ridge to support the roof cladding, are the rafters. Purlins, running between the rafters and parallel to the ridge, helped to stabilise the roof and reduce the span of the rafters. Collar ties were installed in many roofs, usually at mid-rafter span, but sometimes higher or lower, not only to help reduce any sag in the rafters but also to limit the outward thrust of the ends of the rafters, which would otherwise tend to push out the tops of the walls. Variations of collar ties and struts were used including the scissor-braced common rafter roof.

Where stone flags were used as roof cladding, more substantial roof timbers, as well as thick, structurally stable walls, were needed to support the heavy covering. Battens were often not used in these roofs and the flags were secured by nails hammered directly into rafters or purlins. Spans were kept to a minimum and rafters placed close together.

Builders often used timber economically, developing techniques that reduced the need for large or long beams and skilled carpentry. Masonry cross walls were continued into the roof space, allowing for the use of shorter purlins supported between the cross and gable walls. From the early-eighteenth century onwards, ceiling and floor construction was also simplified by using clear spanning joists. The advantage of this long joist form of construction was that it provided a particularly efficient and continuous tie between structural walls. The downside of these long spans coupled with the rather small sizes of joist chosen by many builders is that they tend to result in larger-than-satisfactory ceiling deflections.

The structural timbers of a historic roof are frequently older than the roof covering, which may have been replaced, sometimes several times, in the course of the building's existence. A careful look at the form of the roof, the jointing details and any marks on the timbers can help to date the roof structure. Adze marks, pit-saw marks, merchant marks and assembly marks all provide interesting evidence of the methods used to prepare the timbers for use and to assemble them on site.



A roof detail particular to Ireland was the practice of continuing the masonry cross walls up into the roof space. Purlins were placed to span between the cross and gable walls to support the common rafters. This proved to be a very economical use of timber and also reduced the amount of skilled carpentry work required



Merchant mark 'g I N' on this bay bressummer was exposed during works to repair this beam and the bay roof. Timber marks, where found, should be recorded and preserved and repair works should avoid concealment



A survey of the timber structural elements of a roof often reveals merchant, religious or assembly marks on the historic timbers. These assembly marks on the oak timbers helped the carpenter to assemble the frame once on the roof. Note the pegged joints and the housing of purlins into frames. This is how roofs were constructed before nails and other metal fixings became readily available

DENDROCHRONOLOGICAL TESTING OF OAK ROOF TIMBERS

Dating samples of oak timber by dendrochronology is useful if the significance of the building warrants it. Dendrochronology, or tree-ring dating, comprises the microscopic assessment of tree ring growth information in sections of historic timber, and can provide accurate dates for timber that retains the heartwood-sapwood transition area and contains 100 growth rings (although in some cases as few as 50 rings may be suitable). A full set of data is available for oak grown worldwide.

Several samples are taken in the form of cores drilled from the timber. Approximately ten cores per building are considered necessary to construct an appropriate site profile or chronology. There is no similar test for dating Northern Pine or timber supplied from the Baltic due to incomplete recording and compilation of data on the source and supply of pine.

The process will require the involvement of specialist advice. If the building is included in the Record of Monuments and Places, it should be noted that the extraction of the required sample for dating purposes is prohibited under the National Monuments Acts unless a licence is in place to alter it. The export of a sample abroad (including to Northern Ireland) for dating purposes requires an export licence. If the building is a protected structure, the architectural conservation officer in the local authority should be consulted before any works are undertaken.

FRAMED AND TRUSSED ROOFS

Early roofs over buildings with large internal spaces, such as halls, consisted of timber frames with purlins mortised into their sides. The rafters spanned onto the purlins and frequently were also mortised and tenoned into the purlins. The principal rafters were coupled at the roof apex. The timber frames and purlin arrangement of these 'high roofs' were well known from the twelfth century onwards. These roof types were based on the cruck frame, and variations included simple 'A' frames and scissor beams as well as



A late sixteenth-century oak roof over a large hall at Ormond Castle, County Tipperary



An early-seventeenth century roof showing the original principal roof structure and rafters with replacement sarking boards above (Image courtesy of Tom McGimsey, Mesh Architects)

more elaborate arrangements including hammerbeams. This form of roof construction continued into the eighteenth century and was also frequently used in Gothic Revival buildings of the nineteenth century.

A truss is the name given to a rigid frame of rafters, collar beams and struts capable of spanning large distances without intermediate support. Historically, there are many different types of trusses, each with its own name depending on the disposition of the timbers within the framework, such as king post, queen post, crown post and the like.

By the last quarter of the seventeenth century, the timber roof truss had come into general use, albeit with historical and regional variations, for the more substantial houses, churches and public halls, and remains in use today. Trusses allowed for the construction of roofs with larger spans and differing roof pitches, which impacted upon building design in several ways. Internally, the use of trusses allowed the room layout to become more flexible, as fewer internal supporting walls were required. The use of trusses enabled the construction of lower-pitched roofs, such as those favoured by the Neo-Classical style of architecture. Roof frames and trusses were frequently made off-site, brought up to the roof in pieces, and assembled in situ as it was easier to lift individual timbers up onto a roof than whole frames. Assembly marks (sometimes known as carpenter's marks) ensured that the correct pieces were matched to each other.

THE BELFAST TRUSS

The Belfast truss is the name given to a light, timber truss formed of timber latticework sandwiched between doubled top and bottom timber members, the top member being curved. It is also known as a bowstring truss. The timber used for these trusses was generally pine and the trusses were overlaid with timber decking and various forms of roof sheeting. This form of truss was believed to have been invented in Belfast in the late-nineteenth century to construct the roofs of boat sheds. However, earlier examples have been discovered, dating from the 1850s, which were used by the Malcolmson family to construct economical domestic roofs for the houses of mill workers at Portlaw, County Waterford. At Portlaw, the boarding of these curved roofs was covered with a



The 'Portlaw' roof was also used further afield for housing schemes, such as here in Harold's Cross, Dublin; also in Clara, County Offaly; Blarney, County Cork; and Carrick-on-Suir, County Tipperary. At one point, these trusses were exported to Germany

thick woven cotton material called calico, made in the local mill. The calico was then waterproofed with a tar coating, a by-product of the mill owners' gas works. While there are very few intact surviving examples of a complete roofing system, these trusses, where found, are an important historical and architectural legacy worthy of conservation.

THE USE OF IRON IN ROOFS

Wrought iron was an integral part of the construction of timber roof trusses, providing the strapping and fixings required to hang the ceiling tie from the truss and also to secure the rafter/collar tie connections.

A later development was the use of wrought iron instead of timber as the tie beam, particularly in buildings such as stables and mills that were open to the underside of the roof. By the early nineteenth century, cast- and wrought-iron roof beams and trusses became commonly used in industrial and public buildings. Cast and wrought iron can also be found in the roof structures of features such as conservatories, orangeries and rooflights. Steel gradually replaced cast and wrought iron from the end of the nineteenth century.

Roof details

RIDGES

The ridge is the apex of a double-pitched roof. The ridge piece is the name given to the timber which runs along the apex of the roof and to which the tops of the rafters are fixed. The insertion of a ridge board between the roof timbers was considered a technical advance and distinguishing characteristic of roofs from the early-eighteenth century.

The junction at the ridge, where the roof slopes meet, is a particularly vulnerable part of any roof and should be properly bridged to provide protection from rain and wind. From medieval times, clay ridge tiles have been used to cover this important joint and are found in many designs, profiles and colours. It is known from archaeological findings that, in the seventeenth and eighteenth centuries, decorative cockscomb ridge tiles, some of which had a wave-like form, were used on clay-tiled roofs. From the seventeenth century onwards, lead rolls were used as ridge cappings in high-class roofing work using large timber dowelling to form the core of the rolls. Ridges were also covered with carved and dressed stones bedded in lime mortar, but this was generally limited to the more substantially built structures. Terracotta ridge tiles became standard on eighteenth-century roofs while, in the following century, decorative finials of iron or terracotta were often added for effect, as was iron cresting along the length of the ridge. Sometimes the clay tiles or finials had a further function, concealing a vent to the roof space, while others acted as lightning conductors.

VERGES AND GABLES

The verge is the edge of a pitched roof where it meets the gable wall. Up to and during the eighteenth century, roofs were commonly pitched and gable-ended with gable chimneystacks in buildings of all sizes and in both detached and terraced structures. The most common verge type in Ireland was the flush verge, where the roof covering continued across the top of the masonry gable and the slate or tile covering was fitted tightly to the masonry by bedding the outer slates in a lime mortar. A flush verge has no overhang and in most cases no bargeboard, although there may be a stone corbel in some cases.



The flush verge detail, as seen in this example, is vulnerable to the extremes of weather; the reconstruction of the detail using lime mortar is of particular importance to ensure that there is sufficient tolerance and flexibility for the slates to move

Where there is an overhanging verge, the roof extends over the gable to give it further protection and is finished with a bargeboard, which could be decorated – often with fretwork – and painted. On some nineteenth-century suburban houses in Dublin, square terracotta tiles are used at the verges of the roof. Another version of this detail consisted of the gable built above the roofline with the slate flashed against it.



The overhanging gable detail comprised an extended roof to protect the masonry gable and was finished with bargeboards which could be decorated and painted

EAVES AND PARAPETS

The eaves are the lowest part of a pitched roof, where it meets, or overhangs, the wall top. The design of the eaves is responsible for ensuring that rainwater is thrown clear of the top of the masonry walls. This can be handled in several ways: using a gutter that is flush with the face of the wall below; a concealed parapet gutter; or projecting eaves. In vernacular buildings that do not have gutters, the eaves should simply throw the rainwater far enough off to ensure that the ground at the base of the wall does not become saturated.



In this flush eaves detail, lead is used to form a conduit for carrying rainwater along the eaves of the roof to the downpipe

Projecting eaves with moulded stone cornices were often used in substantial seventeenth- and early eighteenth-century buildings. However, as the Palladian style of architecture emerged, gutters hidden behind parapet walls or in the valleys between low pitched roofs became more popular. Most parapets consisted of plain brick or stone walls capped with dressed stone copings. More elaborate examples incorporated stone balustrades with finials and other ornate decoration.

Pitched roofs with sprocketed (also known as 'bellcast' or 'kicked-out') eaves were fashionable for a time during the early and mid-eighteenth century. Many sprocketed roofs were later modified to remove the secondary rafter from the roof timbers.

In the late eighteenth and early nineteenth centuries, overhanging eaves came back into popularity. A horizontal course of eaves stones or slabs was often fitted overhanging the top of the wall. Timber eaves brackets in this period tended to be deep in section, curved in design and had two points for fixing. This style of bracket was later superseded by driven-in wrought-iron brackets that supported the guttering. The eaves of Victorian and Edwardian structures were robust in profile, overhanging the masonry walls and often picked out in painted timberwork. There was sometimes a timber soffit to the underside of the over-sailing rafters although in most cases the rafter ends were left exposed. Projecting decorative stone or timber corbels were often used to support cast-iron gutters.



In a common construction detail of the late-eighteenth and early nineteenth centuries, a horizontal course of eaves stones was used to project from the top of the wall while a wrought-iron bracket supported the gutter

Roof features

DORMERS

Dormer windows are vertical windows in a sloping roof which have roofs of their own. They are so called because originally they gave light to the sleeping quarters in the attic. Dormers were common until the mid-eighteenth century, when they fell largely out of fashion in Ireland. They came back into favour as an architectural feature during the nineteenth century. Dormers were constructed of timber, with mono-pitched or double-pitched roofs, clad with slate or lead on roof, cheeks (sides) and apron (below the window). Some dormers had glazed cheeks to maximise the amount of light entering the interior.



Pitch-roofed hatches, similar to dormers, were used to provide access to the roof for maintenance purposes. They were generally located in the central valleys, constructed of timber and finished with a cladding of slate or lead. By the end of the nineteenth century they had gradually been replaced by hinged cast-iron rooflights, which provided both daylight and roof access

LANTERNS AND ROOFLIGHTS

Glazed circular, oval, or occasionally rectangular lanterns were used as a means of bringing natural daylight into stairwells or anterooms. Many were glazed with decorated ribbed members and coloured glass.

Hinged cast-iron rooflights set into the plane of the roof became common in the nineteenth century and are still available today. They are used both to improve daylight in the roof space and to access the roof for maintenance.



Glazed lanterns of circular and oval form were inserted into roofs as a means of bringing natural daylight into internal spaces such as landings and stairwells. Frequently these lanterns were poorly maintained because of difficulties of access and they were often replaced or covered over with a replacement roof covering. These circular glass rooflights are part of a nineteenth-century alteration

MASONRY FEATURES

The nineteenth century saw the increasing use of decorative architectural features such as turrets, cupolas, or belvederes, often constructed using cut stone, timber or brick. Substantial decorative corbels and pedimented gable fronts were used with cornice decorations at eaves level to enhance the roof profile on more substantial structures.



Decorative finials and ridge tiles were added for decorative effect and contrast. However, sometimes the use was also functional, for example when concealing a vent to the roof space



At Ballyknockan, the historic stonemasons' village in County Wicklow, dressed eaves and gable coping stones can be seen incorporated into the construction of even the most modest of structures. The use of these architectural details was the result both of an increased awareness of building detailing and also because of surplus rejected stone samples supplied to building projects around the country reverting back to the quarry village

TIMBER AND IRON ROOF FITTINGS AND EMBELLISHMENTS

The decorative expression of architectural features in all forms increased from the mid-nineteenth century onwards. On roofs, the use of timber and iron fittings increased with the development of mass production and improvements in metal processing. Lead- or copper-covered louvred timber vents within the roof plane or circular metal vents were commonly used on churches and larger industrial warehouses. Ornamental features such as weathervanes or finials were increasingly used on more complex roofs that included towers and turrets. Metal-crested ridges, or metal filigree along a ridge or in combination with decorative mild steel hip irons can also be seen on roofs of this period.

CHIMNEYSTACKS

Although primarily functional items, chimneystacks were often used as architectural features to emphasise the symmetry of historic buildings or to add an elaborate flourish to their roofs. They were mainly constructed of brick or coursed stone, often with numerous flues, and finished off with a stone capping and clay pots. From the mid-nineteenth century, Roman cement was used to render chimneystacks with courses lined out in the render in imitation of high-quality ashlar. Decorative projecting cornices and flaunchings were made in mortar, stone or brick. Chimneystacks were positioned in various locations in the building plan for both practical and aesthetic reasons. Centrally placed chimneystacks offered both visual symmetry and the even transfer of heat within the structure, some stacks were also built projecting from gable walls. In vernacular structures, chimneystacks were substantial structures often formed of rammed earth supported on timber bressummers, or beams.

Eighteenth-century chimney pots were simple and unglazed, although designs became more adventurous in the nineteenth century, with decorative brick chimneystacks sporting yellow or terracotta roll- or plain-topped clay pots. Towards the end of the nineteenth century, chimney pots – both round and square – became larger and more substantial, sometimes with decorative square or heart motifs pressed into their top rim.

Flues were generally constructed of brick due to its excellent heat-absorbing properties and because it was easier to corbel and seal brickwork. Inspection may reveal that a flue is common to several fireplaces

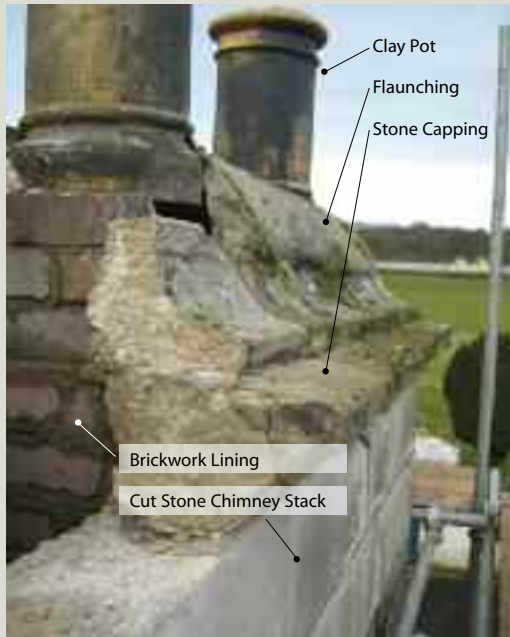

Chimneystacks were traditionally constructed of coursed brick or stone, gathering numerous flues into a single large masonry element often finished off with a stone capping



Glazed terracotta chimney pots are unusual, but examples with green, black and dark brown glazes can still be found with a simple roll-top detail. In this example, the bright green glazed pots match the glazed roof tiles. Further variations included tall dark brown terracotta pots with serrated tops and short plain black pots like crowns

and this issue may have to be addressed, depending on the extent of repairs, as ideally there should be one flue for each fireplace in operation. The point at which the chimneystack enters the roof space is generally where all the flues converge into one or several individual flues. This point of convergence in some roofs was manipulated to form a particular roof profile or detail at roof level. It was mistakenly thought that the more bends created within the flue, the better the draw of the fire. By the eighteenth century a high proportion of the more substantial properties typically had one or at the most two stacks collecting the flues from all the rooms, some of the flues turning one or more corners within the room. This ignored the information provided by John Payne's pattern book, *Twelve Designs of Country Houses* (1757), in which it was noted that the constraints of the flues within the wall thickness and the use of many bends led to the collection of soot. Bends were considered an impediment to the cleaning of flues and Payne noted that this 'evil' belongs only to great buildings.

RAINWATER GOODS

The use of vertical lead pipework for draining rainwater probably came to Ireland with the Anglo-Normans, but gutters and downpipes were originally only used on prestigious buildings. In late seventeenth- and early eighteenth-century structures,



A rare example of a surviving lead hopper head with an embossed date of 1725



Cast-iron rainwater systems often copied the design of leadwork, but the stronger nature of cast iron enabled the use of shallow collars and two-point fixings rather than the deep collars needed to support lead rainwater goods

buildings were built with the central valley made of a continuous narrow cast-iron gutter, instead of the more usual copper or lead gutters formed between internal roof slopes. Lead drainage downpipes were sometimes run within the walls of eighteenth-century buildings and are the cause of considerable damage if they fail.

During the nineteenth century, cast iron replaced lead as the most common material used for rainwater goods. Gutters are held with wrought-iron or cast-iron brackets while downpipes are fixed to masonry with cast-iron brackets. Eighteenth-century wrought-iron brackets tend to be deep and curved with two fixing points while later brackets were simpler and were made of both wrought and cast iron, usually with one fixing point or a spike end which was driven into the masonry at eaves level. The weight of iron gutters ensures that they do not lift in severe weather conditions. In the later Victorian period, hopper heads became more decorative and a feature of elevations. Rainwater downpipes and guttering of larger square profiles were used, no longer painted in lead grey or black, but highlighted in greens or blues as part of the co-ordinated decoration of the structure.

rainwater goods were formed out of lead sheet with lead outlets through parapets, valley gutters, or lead eaves, connecting to lead hopper heads and downpipes. Lead box hopper heads and square-section lead downpipes can still be seen, some with the building construction date embossed on the hopper head. Hopper heads were used to collect and channel the water from the gutters into the downpipes, since gravity drives the mass of water down the rainwater pipe much more effectively if there is a head of water.

In terraced buildings, long lengths of lead-lined parapet gutters were used. These gutters were built into the space between roof and parapet and were laid to a fall or gentle slope, sometimes stepping across many building fronts to a common hopper head and downpipe. Internal valleys were serviced with a 'secret gutter' made of a timber box section lined with lead that directed rainwater through the attic space to a chute on an external wall. Some

Getting the right advice

When it comes to repairing a building, regardless of its age or size, it is important to know when specialist advice is needed and where to find the right help. It is a false economy not to get the best advice before having work carried out. Bad repair works can be difficult and expensive to undo. They can damage a building in the long term and devalue your property. In addition, the interpretation and application of the more technical recommendations in this guide should be entrusted to suitably qualified and competent persons.

You will need the right advice for a particular job. Sometimes you will require a craftsman, or an architect, a surveyor or a structural engineer. Sometimes you will need specialist advice from someone with a particular expertise, perhaps in slating techniques, structural timber repair or leadworking. At the outset, and particularly if your building is a protected structure, you may need advice on whether the proposed works require planning permission or not. When undertaking a large or complex conservation and repair project, a multi-disciplinary team may be required. Most importantly, you should ensure that any advisor is independent and objective. Avoid taking advice from someone trying to sell you something, or someone with a vested interest in increasing the scale and expense of work. Many building professionals and contractors are principally involved with modern construction and may not know how to deal sympathetically with an old building. You need someone who understands old buildings, has experience in dealing with them, and has trained to work with them. He or she should be knowledgeable and have experience in dealing with your type of building.

When employing a professional advisor or a building contractor, check their qualifications and status with the relevant bodies and institutes. Ask for references, and for the locations and photographs of recent similar work undertaken. Do not be afraid to follow up references and to visit other building projects. A good practitioner will not mind you doing this. If you see a good job successfully completed on a building similar to yours, find out who did the work, whether they would be suitable for the works you want to undertake, and if the building owner was satisfied.

Try to get at least three written estimates or quotations for the work from suitable contractors. Do not make your final choice based on cost alone. The cheapest quote you receive may be from a person who does not fully understand the complexity of the problem. Do not make payments for work until you are satisfied it has been correctly completed.

Be clear when briefing your advisor about what you want him or her to do. A good advisor should be able to undertake an inspection of your property, give you a report identifying the causes of damage, make a careful diagnosis of the problem, recommend repairs, specify the work required, get a firm price from a suitable builder or craftsman, and oversee the work on site as it progresses. If your building is likely to need ongoing works over a number of years, your relationship with your advisor and builder will be important both to you and your building, and continuity will be a great advantage. They will be able to become familiar with the property, and to understand how it acts, and will build up expertise based on your particular building.

The Royal Institute of the Architects of Ireland (RIAI) has an accreditation system for architects trained in building conservation and can provide a list of those architects that are accredited. Similarly, the Society of Chartered Surveyors has a register of conservation surveyors. The Construction Industry Federation also has a register of Heritage Contractors working in the field of building conservation. The architectural conservation officer in your local authority can provide general advice and may be able to give advice on suitable professionals, craft workers and suppliers in your area.

3. Cladding Materials and Methods

Slate

THE FORMATION OF SLATE

The word 'slate' comes from the Middle English 'slat' or 'sclate.' It is related to the French word 'esclater', which means to break into pieces and refers to the cleaving characteristics of the rock.

Slate is a naturally formed metamorphic rock extracted or mined from discovered seams within the ground. These seams were formed millions of years ago by great pressure exerted on mud layers, containing key clay minerals, lying on the base of shallow seas. During massive earth movements, areas of the sea bed were uplifted into mountains and the mud, now covered by sedimentary shale, was subjected to tremendous heat and directional pressures causing the minerals present in the mud layers to crystallise into rock layers. The re-orientation of clay minerals in parallel planes to the forces of greatest pressure is described as 'fissility', and the ability to split along these planes is called 'cleavage'. It is this particular formation process that gives slate its chief characteristics and differentiates the material from the thicker sandstone flags also used in Ireland as a roof covering.

SOURCES OF IRISH SLATE

'..... slates are to be got in most places, on reasonable terms; all along the eastern sea coast, slate from Wales can be procured – and in the interior, both north and south, valuable quarries are accessible. All along the line of the Shannon, and the channels connected with it, the Killaloe slates are procurable – and perhaps, not even Wales itself can produce a more lasting, or manageable slate than the Killaloe quarries can produce...'

The Dublin Penny Journal (1833)

Regional Irish slate possesses a wide range of colours and textures, from the coarse and heavy Clare slate to the smooth and light appearance of Valentia Island purple slate from County Kerry. Because of these characteristics, as well as its rarity, Irish slate is particularly worthy of identification, protection, and retention.

Reports and published descriptions dating from the nineteenth century identify the location, operation and output of Irish slate quarries. The survey work of the Geological Survey of Ireland (GSI), compiled just after the first Ordnance Survey, is an important archive. To date, 217 references to slate locations in 19 counties have been established by the GSI. Samuel Lewis's Topographical Dictionary of Ireland (1837) identified and described the quality and location of at least 122 sites for quarrying slate. County Cork was considered to be the most significant producer of slate, followed by counties Kerry, Tipperary, Clare, Wexford, Waterford, Kilkenny and Wicklow, with small pockets identified in counties Mayo and Donegal.



View of a worked slate quarry at Roshine, County Donegal



A selection of slate, both imported and native, indicating the wide variety of colour, texture and size available

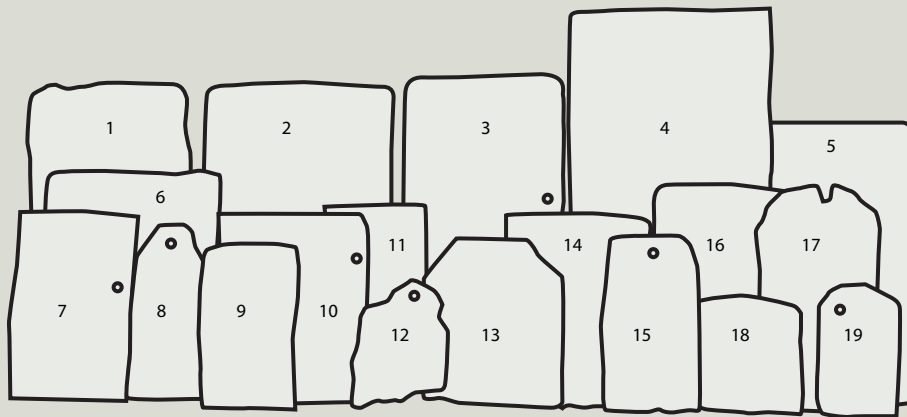

- | | |
|---|--|
| 1. Ahenny, counties Kilkenny/Tipperary | 11. Canadian Heather Plum, Trinity Bay, Newfoundland, Canada |
| 2. Chinese Grey | 12. Stone Quality Slate |
| 3. Delabore, Cornwall (double fixed historic sample) | 13. Westmorland Blue/grey, Cumbria |
| 4. Glaslacken, County Wexford | 14. Campo Grey, Spain |
| 5. Penrhyn Heather, Wales (modern 'Blue Bangors') | 15. Glaslacken, County Wexford |
| 6. Weathering Green, Vermont, USA | 16. Permanent Green, Vermont, USA |
| 7. Welsh Grey (Cwt-y-Bugail and Greaves Quarries, Wales) | 17. Broadford, County Clare |
| 8. Stone Quality Slate (oak pegged with single head nailed) | 18. Westmorland Green, Cumbria |
| 9. Corbally/Garrybeg, County Clare | 19. Delabole, Cornwall |
| 10. Killaloe, County Clare | |

Historically, there were few large scale quarries operating in Ireland. Those at Benduff, County Cork, Valentia, County Kerry, Broadford and Killaloe, County Clare and Ahenny, County Kilkenny were the exceptions, producing the greatest quantity of native slate within the country. The quarry at Valentia was worked from 1816, when it was opened by the Knight of Kerry, and expanded greatly in the early nineteenth century; it was the second-largest ever quarried in these islands. Although Valentia slate was used mainly as flagstone, there are examples of surviving roofs to be found in the Listowel area, and Valentia slate was used to roof the Houses of Parliament in Westminster. It is a very durable slate of dark grey with a purplish hue in the hand, whilst appearing black when on a roof. The Ormond and Victoria Quarries, located on either side of the Lingaun River on the Kilkenny/Tipperary border near Ahenny, supplied approximately 10 per cent of the Irish market before the Great Famine. Samuel Lewis described Ormond Quarry as *'an extensive quarry of slate of superior quality ... in which about 150 persons are generally employed, the slates have an extensive sale in this and adjoining counties, being considered nearly equal to the Welsh slates in colour and lightness; the quantity annually raised is considerable, and the works have been extended to a depth of 120 feet.'*



Salvaged sample of Ahenny slate. A series of quarries on the Tipperary/Kilkenny border made this one of the more prolific areas of slate production in Ireland in the nineteenth century

The same geological vein produced Killaloe, Broadford and Portroe slate. Records from these quarries indicate that they employed Scottish and Welsh slate workers, who brought their slate-handling techniques with them. Broadford had been quarried for slate since medieval times for its use on castles as well as large country houses in the area. However, access to transport was crucial and the use of Broadford slate declined in the 1800s when the Portroe and Killaloe seams began to exploit their proximity to the River Shannon. These quarries were able to use the Shannon waterway for distribution and for this reason became significant providers of slate, at one time supplying 65 per cent of the Irish market.

Moher/Liscannor slate came from a number of quarries sited between Doolin and Liscannor, and was generically named after the port from which it was exported. This area also produced stone flags for roofing.



Convoy slate from County Donegal is a grey/black slate; its small size and appearance make it almost similar in appearance to a tile. It was widely used in Dublin during the housing boom in the early part of the twentieth century and can be seen on local authority housing projects, such as buildings in the suburb of Crumlin. Benduff slate from County Cork was also used in some housing schemes of the time

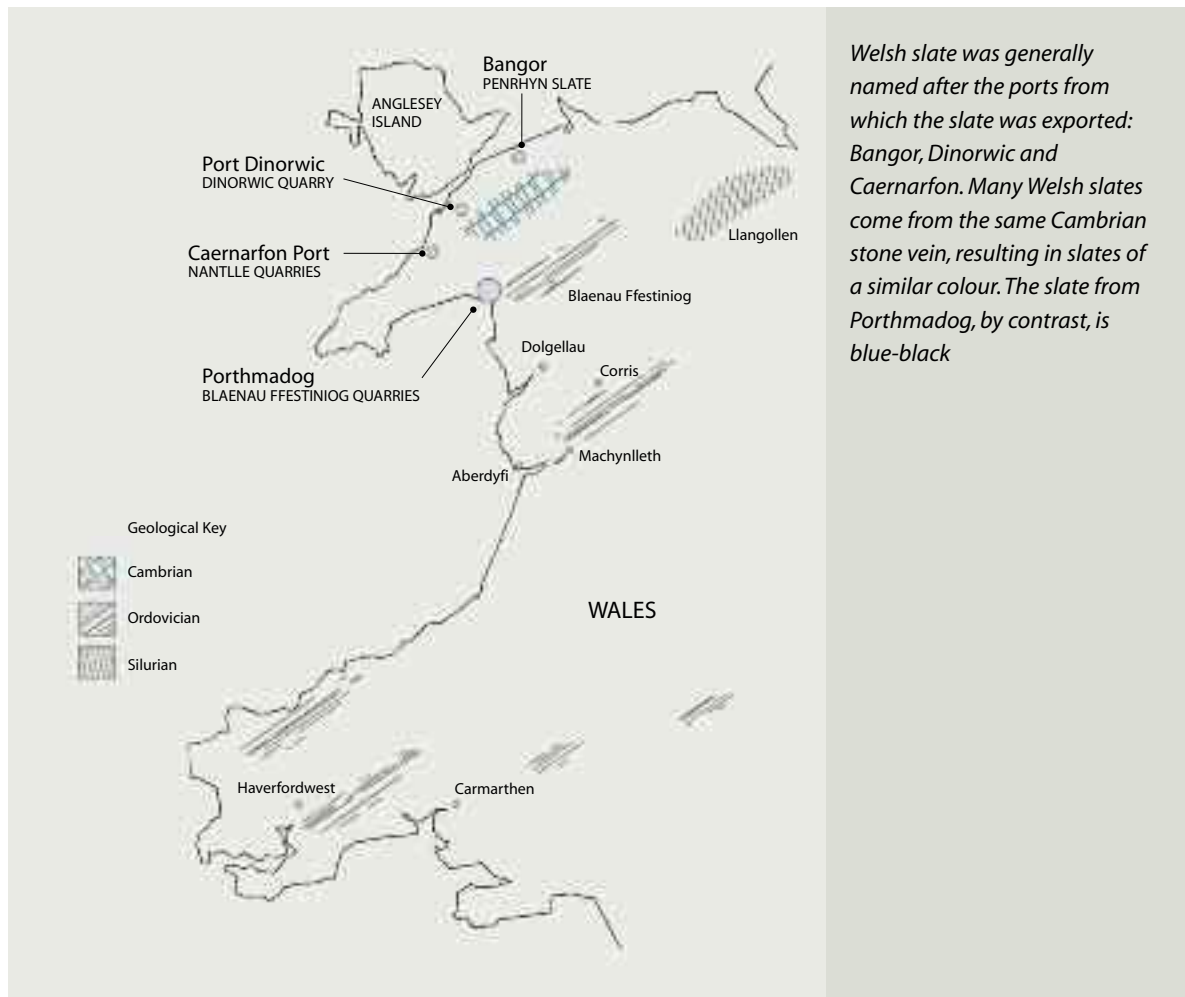

IMPORTED SLATE

The development of canal and railway networks across the country from the late eighteenth century onwards ensured not only the widespread use of native slate, but also facilitated the increased use of imported slate. Shipping records indicate that substantial quantities of slate were imported into Ireland during the eighteenth and nineteenth centuries, mainly from Wales. During the nineteenth century, the intensification of slate production from the Welsh quarries finally drove many Irish slate quarries, which were less mechanised than their Welsh counterparts, out of business. There is also evidence that Irish builders bought Welsh slate for use on roofs, even in towns such as Nenagh and Ennistymon, both of which were close to several local quarries. Slate was also imported from America and Italy.

Slates from Wales vary from reddish and bluish purple to black to light green. Penrhyn slate (Blue Bangor), the most commonly found Welsh slate, is heather in colour. Some Penrhyn slate has a green olive mark in the heather rock, which is considered its distinguishing feature or characteristic. Caernarfon slates are usually a deeper shade of heather than the Blue Bangors, and vary in intensity to a deep heather colour known as 'plum reds'. A paler heather slate from Cardigan in South Wales was used in Cork and Waterford.

Ballachulish slate was imported from the Highlands of Scotland. It is dark or silver-grey in colour and usually only available in small sizes. Westmorland slate, which is quarried in the Lake District in England, is a thick green or grey slate with a rough surface that shows no grain. Westmorland Greens were used in several restorations of the roof at Christchurch Cathedral, Dublin.

Some of the more than twenty sizes and standards of slate used up until 1933, when the use of names was dropped:

Kings	36 x 20 inches
Queens	34 x 20 inches
Princesses	24 x 14 inches
Duchesses	24 x 12 inches
Marchionesses	22 x 11 inches
Countesses	20 x 10 inches
Viscountesses	18 x 9 inches
Ladies	16 x 8 inches
Doubles	12 x 10 inches

Slating methods

FIXING OF SLATES

The small, irregular, hand-shaped slates used in the eighteenth century were generally fixed in place using wooden (often oak) pegs fixed through the heads of the slate (using single or double holes) and fixed over the top of the timber batten. Battens are lengths of timber, small in section, placed horizontally on top of the rafters and nailed to them. Wooden pegs were thoroughly dried out before use and then re-hydrated so that they would swell in the slate and add greater security to the fixing. The fixed slating was finished with a layer of lime plaster, or parging, applied to the underside.

The fixing of slate with handmade wrought-iron nails became common in the eighteenth century. Copper nails were subsequently used, as iron was prone to corrosion, which could lead to premature failure of the roof covering. Larger slates were nailed in place on battens set at intervals that related to the desired overlap between slates. A greater lap was possible with larger slates than with smaller dimensions. The slate was often fixed in diminishing courses ranging from large slates at the eaves to smaller slates at ridge level, as it was an economical way of using slates of varying sizes. The band detail created by the large slate at eaves level is one of the quintessential characteristics of a historic roof. It is a particular characteristic of Irish roofs and it should be preserved where possible in subsequent re-roofing projects.

PARGING AND DECKING

Traditionally, the underside of slates was coated with lime mortar to the interior of the roof space, a form of weathering called lime parging. It was done to counteract wind suction and to give additional security against driving rain, as only a small area of overlap could be achieved between adjoining rows of small, shaped slates or tiles. It also consolidated the slates or tiles and prevented them rattling. Lime parging preceded the technology of roofing membranes to combat draughts and water ingress into the roof space.



Remnants of parging to the underside of slates



A method of slating sometimes referred to as 'open slating', 'hit-and-miss slating' or 'Scottish cant'. This slating pattern economised on the number of slates used and was primarily used for outbuildings. It is difficult to repair without face-fixing and the amount of exposure of slate surface can make the slates brittle for reuse

The use of timber sarking or decking (jointed sheeting fixed directly to rafters) was used in some high-quality nineteenth-century work. This system of boarding out, occasionally with battening on top, was considered a superior construction detail in areas of severe exposure and where high snow loads were an issue. It is still a traditional form of construction to be found in the north of the country, but was less commonly used in the south. Decking is also found below complex roof forms, such as curved bays, where the roof pitch is minimal and slates were fixed directly to the boarding. The boarding on the curved sections of roofs was fixed diagonally so that the joints did not run parallel to the slate joints. This ensured a greater radius to curve the boarding as well as better protection from water ingress.

The setting of slate onto a bed of lime supported by closely spaced riven laths fixed to the upper face of the rafters was a very early eighteenth century detail known as a 'wet roof' construction. The bed of lime was used to accommodate the handcut, irregular, uneven slates generally available from local quarries. There are very few surviving examples of this type, as most roofs on historic buildings tend to be replaced several times over the life of the structure. Occasionally, areas retaining mortar remnants with riven laths and perhaps a few irregularly pegged slates may survive from when the roof was modified or over-roofed. This type of discovery can be a good indicator



The recent discovery, within a later roof space of part of the former medieval friary in Ennis, of closely spaced riven laths fixed onto covered-over rafters substantiated the presence of an earlier structure within the historic fabric

of the age and development of the building, and evidence of this nature discovered within a roof should be recorded. A full wet roof existed on Buncrana Castle, County Donegal (1718-19) and this technique was replicated during re-roofing works in the 1990s. Remnants of this type of roofing have also been found on the larger eighteenth-century buildings such as Castletown House, County Kildare.

VERTICAL SLATE HANGING

Vertically hung slate is a weathering detail found in exposed elevations. It was frequently used in towns throughout Munster, particularly in coastal areas, but examples can be found countrywide. Vertical slate cladding was often used to cover sandstone rubble masonry where it was difficult to achieve a watertight external render. On some buildings, patterns in clipped slates or contrasting colours were used. Vertical slate hanging was used to protect those parts of buildings that are inaccessible and hard to maintain or are particularly exposed to weather, such as parapets, chimneys and gable walls. Frequently, slate hanging was used to clad the full internal face of parapet walls instead of lead.



The best surviving examples of native Irish slate are most often found in vertical slate hanging, as it requires less frequent replacement than roofing slate. It is thought that this example of a slated gable is covered in Ahenny slate from the nearby Ormond quarries in the Carrick-on-Suir area

Vertical slate hanging was carried out in a similar manner to wet roofing (see above). The wall was plastered with a lime mortar, which was allowed a few days to set. Lime mortar was then applied to the underside of the slates, which were placed in position like wall tiles. The slates were fixed at the head using wrought-iron nails with a thin shank. This fixing curled on fitting, forming a secure fix into the lime mortar. The mortar bedding delayed corrosion of the iron nails.

Vertical slate hanging to parapet walls was generally carried out with the face of the slate set into a wet lime mortar plastered onto the wall. This was also a technique used in small roof areas and projections where a rough surfaced slate was used to provide more purchase to the lime. Vertical slate hanging ensured a good run-off of rainwater. This meant that the headlap may have been as little as 50mm. Sometimes shouldered slate (slates with the top corners cut off) were used, as were off-cuts or less expensive slate.

In some instances, vertical slate hanging is found covered with a coarse lime dashed render to provide a waterproofing layer. This detail was used both internally and externally, for example at parapet level. The existence of the vertical slate detail typically does not come to light until the covering plaster fails, revealing the unusual construction underneath.

Stone slab

HISTORICAL CONTEXT

Sandstone slabs or flags were historically used as a roofing material, principally in west County Clare where suitable stone was locally available. These load-bearing flags, sometimes referred to as stone 'slates', are laid in a different manner to traditional slate roofs and possess particular characteristics. Stone slabs were used on roofs in other areas of the country where similar geological formations occur, such as in the north Kerry/west Limerick area, and in areas of counties Carlow, Kilkenny, Laois, Leitrim and Tipperary. While the largest number of stone roofs exist in County Clare, a small number of stone slab roofs, mostly on outbuildings, survive in counties Leitrim, Donegal and north Roscommon.

STONE CHARACTERISTICS

The term 'Liscannor stone' is used generically to describe any fissile sandstone that displays the fossilised tracks of marine life (molluscs, arthropods and worms) that existed 320 million years ago, such as that quarried at Moher and Miltown Malbay. Doonagore stone flags are distinguishable by a dimpled or rippled texture. Luogh slabs are smooth, with ingrained colours ranging from blue/black and grey/brown to russet. Quarries are still worked at Luogh and Moher, providing slab sizes ranging from 1150 x 880mm to 450 x 450mm, with thickness varying between 13mm and 25mm.



A rare surviving example of a stone slab roof in County Donegal showing a building covered with flags of a local stone

SETTING STONE SLABS

The limitations of the material did not allow for details such as hipped roofs, valleys or dormer windows, and so stone slabs are generally found on simple gable-ended roofs. Due to the heavy weight of the slabs, the roof structures that support them tend to incorporate large, closely spaced timbers. Stone slabs are generally used on roofs with a pitch of no steeper than 40 degrees.

The size of available slabs appears to have dictated where the batten was placed so as to provide an adequate lap. Each successive course of stone slabs (known locally as 'flags' due to their large weight and size) were chosen to provide adequate headlap over the course below. Luogh flag, due to its smoother nature, requires a lesser lap. The flags were laid with the heavier and larger ones at the eaves, diminishing in size towards the ridge, where the smallest flags were placed. Stone flags were traditionally attached by iron nails through a double set of holes located near the head of the slab, or via side notches. Alternatively, flags could be pegged and hooked over the battens. The heavier and thicker flags were often simply hung from nails, which rested in notches picked out from the underside of the stone. These flags could be up to approximately 2 inches (55mm) thick. The immense size and weight of these stones meant that as a rule they stayed in place without need for fixings.

Clay tile

HISTORICAL CONTEXT

It is believed that the first single-lap clay roof tiles were formed from baked earth or clay around 2700 BC. The Romans were the first to use clay tiles as a roof covering. The earliest clay roof tiles known to have been used in this country were found in Dublin and date from the eleventh century. Their use is thought to have been introduced by the Anglo-Normans. These early tiles were curved and flanged in form and generally measured 10.5 x 6.5 inches (265 x 165mm), although a few makers produced tiles of 11 x 7 inches (280 x 180mm).



An Arts and Crafts style clay-tiled roof with tile hanging to the upper part of the gable

Up to the eighteenth century, clay tiles were used on public buildings or larger houses. Pantiles (clay tiles with a double-curved 'S' profile) were imported in great numbers from Europe to Irish ports in the seventeenth century. The use of clay tiles, both plain (flat) and pantile, continued into the eighteenth century. Pantiles proved popular as they were larger in size than plain tiles (requiring fewer to be laid per roof slope), and had a larger, more watertight lap. Pantiles are known to have been used in Trinity College Dublin in the mid-1730s on the Printing House and on the new Dining Hall in 1740. None of these early clay-tiled roofs survives intact.

Clay tile as a roofing material was used less during the latter half of the eighteenth century, when slate became the preferred material for cladding roofs. However, clay tiles came back into fashion in the late nineteenth century, due not only to the influence of the Arts and Crafts style, but also because of the lower cost of manufacture compared to slate. The late-Victorian and Edwardian periods saw the increased use of clay tile on the roofs of houses in the new suburbs of Dublin, Cork and Belfast, and to a lesser degree in country areas, although overall its use remained small in comparison to slate. However, many slated roofs were finished using clay tiles to the hips and ridges, employing varying colours and designs. Much of the clay tile supplied to Ireland at this time was of English origin – including flat clay tiles and specialised designs such as bonnet tiles, profiled pantiles or interlocking Roman tiles with several rolls. The majority came from Staffordshire, although interlocking clay tiles were also imported from an area around Bridgwater, Somerset. Some terracotta was manufactured in Ireland towards the end of the nineteenth century, but whether it was in the form of roof tiles or other building elements such as chimneypots remains unclear.

TILING METHODS

Handmade clay tiles were generally head-fixed with timber pegs and bedded into lime. The tiles were often uneven, and in some cases bowed, so the lime mortar functioned to seal the roof from wind and rain. Machine-made tiles were produced with a nib at the top, designed to hold the tile onto the batten. Nail fixing was required at all verges, openings and edges of the roof and at every third course. With interlocking tiles the fixings were less frequent. Tiles were single-lapped at head and side with the weight of the tile largely holding it in place. The tiles were nailed at the ridge and eaves and every third course in between. Occasionally they were fixed vertically instead of horizontally. A larger or wider tile was used to weather the verge.

Lead

HISTORICAL CONTEXT

Lead sheet is one of the most versatile and durable of roofing materials. When properly detailed and fixed, it has been known to last for hundreds of years. It has been used in Ireland since Anglo-Norman times. Lead was mined in several parts of Ireland from the seventeenth century onwards. A survey of 1650 refers to a mine near Kilmore, County Tipperary having supplied lead for the roof of the O'Brien Castle at Bunratty, County Clare. There were also lead mines recorded in the eighteenth century at Ardmore, County Waterford, Loughlinstown, County Dublin and Silvermines, County Tipperary. Transportation costs appear to have been the main limitation to the distribution of Irish-produced lead, and the building industry largely depended on imported material.



Lead sheet, while very durable, is soft. In this example, the lead sheeting has been etched with graffiti over centuries

TYPES OF LEAD SHEET

Cast-lead sheet was originally made by pouring molten lead onto a bed of moist sand. Historically, this work was often carried out on the building site. The quality of sand-cast sheet was dependent on the skill of the caster, the blend of reused lead and new ingots in the mix, and the existence of trace elements such as silver. Traditional sand-cast sheet weighed between 6lbs and 12lbs per square foot and was generally thicker than that produced by later methods. Imperfections arising from air bubbles and sand holes frequently resulted in the weakening of the sheets, and hence cracking and splitting after laying. Sand-cast sheet is recognisable by the stippled surface

finish of the sand face. Sand-cast sheet can be used facing either way up; local tradition would appear to determine which way. It is still produced by specialist companies for significant projects, but may have to be imported.

Machine-cast lead sheet, also referred to as the Direct Method (DM) lead, was introduced in the 1980s. It is available in a full range of thicknesses for roofing works and is manufactured by companies under Agrément certificates. It is more akin in appearance to milled than sand-cast lead.



New lead sheet is supplied in rolls. Depending on the code specified, it can be exceedingly heavy and needs to be lifted with care. Despite this it is vulnerable to theft

Milled lead was invented around 1680. It was originally manufactured on rolling mills and hence became known as milled-lead sheet. It began to replace sand-cast lead sheet at the beginning of the nineteenth century. Today, nearly all the lead sheet used in building is in this form. The rolled lead sheet made today is free from defects and of a uniform thickness. In practice there is little difference in performance between well made sand-cast and rolled lead sheet, other than the less regular appearance of sand-cast lead. The different densities of lead sheet are described by 'Codes.' Milled lead sheet is available in Codes 3 to 8 (least to most heavy).

FIXING LEAD SHEET

Lead was always an expensive building material, and so it was used sparingly and then only on high-quality buildings. It is very easily and successfully recycled, so it has always had a high second-hand value and thus has been prone to theft.

Historically, plumbers (those who worked with lead) were responsible for the forming of gutters, rainwater pipes and flashings in lead as well as the cladding of domes, dormers and cupolas. Individual sections of lead sheeting were laid on timber boards and joined together with hot solder or jointed using standing seams, rolls and drips formed over timbers that allowed some movement of the sheets. The sheets are fixed using lead clips nailed in place, or frequently the sheet itself is nailed directly to the timber substrate, generally with copper nails.



In high-quality work, the visible edges of lead flashings were cut to decorative shapes

Widespread problems due to poor casting of lead sheeting, inappropriate detailing and fixing resulted in the failure of many lead roofs and had given lead a poor reputation by the end of the eighteenth century. The inappropriate copying of ironwork details into lead was another cause of leadwork failure, but this is more apparent in reproduction or repair work of the Victorian period onwards.

Copper

Copper sheet has been used as a roofing material in Europe since medieval times, particularly on some of the continent's great churches and cathedrals. However, its first use in Ireland would appear to date to the late eighteenth century, when its material qualities for the covering of roof features such as domes and cupolas were first appreciated. As it is a lightweight material, copper has a significant advantage over lead when working on high roofs. Copper can be lifted into place with less effort and worked on more efficiently in comparison to the lead sheet. When installed correctly, copper can survive for as long as lead. Copper was used for covering flat roofs in the twentieth century, for weathering masonry parapets and as an alternative to lead for use as flashings.



Copper was used to clad eye-catching architectural features on buildings, embellishing elements such as cupolas, domes and steeples

Copper is a salmon-pink colour when newly made. Within a few days the surface colour turns to russet brown and this continues over a few years until it becomes a chocolate brown. The distinctive light green patina (sometimes referred to as verdigris but not chemically the same) seen on historic copper roofs is a protective film of copper sulphate. It can take between 5 and 30 years to form, depending on the orientation and exposure of the building.

Carbonate and chloride salts of copper may be present in varying concentrations in the protective patina, and in marine areas chloride salts may form an essential part of the patina film. This characteristic can be turned to good effect on roofs by placing a copper strip below the ridge tile and using the run-off to disperse moss or lichen build-up.

A disadvantage of the use of copper is the coloured run-off of rainwater from copper sheeting, which can stain the building materials below.

FIXING COPPER SHEET

Traditionally, copper sheet was worked by hand on site and jointed with standing seams in panels of approximately 250 to 725mm in width x 1750mm in length. Single- and double-lock welt seams were used across the falls and also in valley and parapet gutters.

The sheets and rolls or seams were laid vertically, or at an angle from the vertical, onto timber decking with an isolating underlay of building paper or felt. Where copper and/or copper clips are fixed to the substrate, copper nails of typically 25 x 2.6mm diameter with a minimum 6mm head are used. From the late nineteenth century, when copper sheeting could be produced in thin sheets of consistent thickness, conical timber batten rolls were introduced. By the 1930s the common near-square timber batten with a separate copper capping was found to produce fewer problems at junctions and meant fewer instances of cracking. This is still the preferred batten roll detail today. Both the above systems are referred to as 'traditional' and both approaches are applicable for repairs and for small roofing areas. Traditional copperwork is typically formed using minimum 0.6mm thick, cold-rolled copper sheets.

From the latter part of the twentieth century the 'long strip system' was adopted for large roofs, allowing 670mm wide x up to 8.5m long strips to be used on shallow falls of up to 4 degrees. This long strip system can be particularly useful in sheeting large flat roofs and long, shallow parapet and valley gutters.



Copper can be laid to very shallow falls as in this copper-lined parapet gutter. It can be used to resolve situations where the falls necessary for stepped lead gutters cannot be achieved



Copper used for the decorative trimming of architectural details on a mansard roof and dome, its green hue complementing the pale grey of the slate and stonework

Corrugated iron

Corrugated-iron sheet was first patented in England in 1828 and was used in Ireland for the cladding of both roofs and walls from the 1860s onwards. By this date most of the sheet was in fact galvanised corrugated steel rather than rolled sheet iron, but it is generically referred to as iron.

Historically, corrugated iron in Ireland had a regular wave pattern. Corrugated sheets allow for the overlapping of individual sheets by as little as one corrugation. The sheets were fixed to the structural framework using washers and galvanised bolts or nails driven through every third or fourth wave crest. The sheeting can tolerate low pitches and curved roof forms such as used on hay barns.

While corrugated iron was used predominantly on industrial and farm buildings, Ireland has an array of corrugated-iron building types, some of them landmark structures such as churches, railway buildings and boat houses. Some structures were constructed entirely from corrugated iron imported as self-assembly kits, fitted onto a timber structure. Corrugated-iron sheeting was also used as a cover on older thatched roofs to provide increased weatherproofing of the roof.



Corrugated buildings often came in kit form from as early as the 1860s, and were used for a variety of different purposes. Corrugated-iron housing was more predominant in the mid-twentieth century. Often seen as temporary, these structures have, in many cases, lasted over 100 years

Other roofing materials

TIMBER SHINGLES

Timber shingles are thinly sawn pieces of timber of cedar, oak or chestnut, used in roofing or for cladding a feature such as a roof lantern or spire, and sometimes as an external wall cladding. The Romans introduced timber shingles as a roofing material to Britain. References to their use in Ireland occur as early as the eighth century, with Queen Maeve's palace described as having a 'roof of shingles'. It is probable that difficulties in obtaining a ready supply of oak in Ireland from the early eighteenth century led to the demise of the use of timber shingles as a roofing option. Today only a handful of buildings in Ireland have shingled roofs.



Now usually machine-sawn cedar, chestnut or oak, shingles were traditionally cleft or split. They can be found on the roofs of buildings such as a cottage orné or on decorative architectural features such as roof lanterns or lych gates

GLAZING

Patent glazing set into the pitch of the roof was often used to light the interiors of industrial structures, but is found on many types of building. It is formed by an armature of timber or metal set onto the roof structure on one or both sides of the ridge. Glazing bars extend the full length of each side, glazed in panes fixed by gaskets. The glazing is weathered to the upper and lower edges of the framework with lead or zinc flashings. Similar construction methods are used for projecting roof lanterns.

Fully glazed roofs, such as conservatory roofs, were usually constructed using timber or iron armatures, with glazing bars extending the full length of each pitch. The glass sat directly onto the framework in panes of less than a metre long. Each was curved to the lower edge to throw off water, and to lap over the pane below. The panes were puttied at the sides only.



Glass roofs, using timber or iron structural elements, were used on conservatories and greenhouses and can be extensive

SHEET MATERIALS AND METALS

Other roofing materials include seamed zinc sheet, which is described as bluish-white in appearance and as a medium hard metal which is reasonably brittle, particularly at low temperatures. From the mid-eighteenth century it was used for roofing and in the 1830s it began to be used for sculpture and decorative elements. Today zinc is used to provide a protective coating on steel through processes such as galvanising, sheradising and zinc spraying, or as a fashionable roofing material for contemporary roof profiles.

TARRED CLOTH, ASPHALT, CONCRETE AND ASBESTOS

Tarred cloth was used in the 1850s for cladding the lightweight curved pine 'Belfast' trusses constructed on the workers' houses introduced by the Malcolmson family in Portlaw.

Hot rolled asphalt was available from the 1890s and, although used infrequently at that time, it became much more prevalent in the twentieth century, when flat roofs came into fashion. Asphalt shingles were also available from the late-nineteenth century and became prevalent from the early to mid-twentieth century as an economical substitute for natural slate and tiles.



Asphalt shingles were introduced as early as 1890, although their use is more usually associated with buildings dating from the 1930s

Concrete tiles and asbestos sheeting became prominent in Ireland from the 1930s onwards, particularly on local authority housing schemes.



This set of slates indicates a sequence of re-roofing projects, over a period of centuries, on an early eighteenth-century country house. On the left, the small greenish, hand-dressed slates, held in place by pegs fixed into lime mortar, are thought to represent the original roof covering. Clay tiles may have been used to cover the ridge; the fragment shown here (top left) was found in the attic space of the house. An extension to the house in the 1800s appears to have been the impetus for re-cladding the entire roof with a blue-grey slate in a gauged slate pattern, possibly Ahenny slate (second from left). This roof survived until the mid-1960s, when neglect over time had caused serious damage and undermined the roof covering. The roof

was then re-slatted with an artificial fibre-cement tile or 'slate', retaining one section of the 1800s blue-grey slate roof to the central valley. In recent times, the roof has been fully re-clad using a high-quality natural Welsh slate, seen on the right.

This sequence highlights the number of times a historic roof may be altered or replaced over the lifetime of a historic building and how the materials and details change in the process. The original small hand-dressed slate would have provided a very different visual effect in terms of colour, texture and pattern from the recently laid machined and regularly sized Welsh slate

Legal protection of historic buildings

It is important to establish at an early stage whether a building is protected by legislation and what types of notifications, permissions and/or consents it may be necessary to obtain before undertaking any works. This section is intended as guidance only and is not a legal interpretation of the legislation referred to below.

NATIONAL MONUMENTS ACTS 1930-2004

A historic building may be protected under the National Monuments Acts in one or more ways as follows:

- a) By reason of being a national monument in the ownership or guardianship of the Minister for the Environment, Heritage and Local Government or a local authority or subject to a preservation order;
- b) As a monument entered in the Register of Historic Monuments;
- c) As a monument entered in the Record of Monuments and Places.

In respect of monuments to which (a) applies, the written consent of the Minister for Environment, Heritage and Local Government is required for any structural interference or ground disturbance. In respect of monuments to which (b) and (c) apply, two months' notice in writing must be given to the Minister of any proposed works at or in relation to the monument. Breach of these requirements is an offence.

The Record of Monuments and Places (RMP) is the most widely applying provision of the National Monuments Acts. It comprises a list of recorded monuments and accompanying maps on which such monuments are shown for each county. It can be consulted in county libraries and main local authority offices. The National Monuments Section of the Department of the Environment, Heritage and Local Government will advise on the protection applying to any particular monument under the National Monuments Acts.

PLANNING AND DEVELOPMENT ACTS 2000-2006

Alternatively, or in addition, a historic building may be protected under the Planning and Development Acts by being included in the Record of Protected Structures (RPS) of a particular planning authority or by being located within an Architectural Conservation Area (ACA). Where a building is a protected structure (or has been proposed for protection) or is located within an ACA, the usual exemptions from requirements for planning permission may not apply. In the case of a protected structure any works which would materially affect its character will require planning permission. Legal protection also extends to other structures and features within the curtilage of a protected structure such as out-buildings, boundary walls, paving, railings and the like. In an ACA, any works to the exterior of a building which would affect the character of the area also require planning permission. Owners and occupiers of protected structures have a responsibility to maintain their buildings and not to damage them or allow them to fall into decay through neglect.

A notice is sent to every owner and occupier of a protected structure when the building first becomes protected. The Record of Protected Structures can be consulted in the development plan for the area. If a building is a protected structure, or if it is located in an ACA, the planning authority will be able to advise what this means for a particular property.

The owners or occupiers of a protected structure are entitled to ask the planning authority in writing to issue a declaration which will give guidance on identifying works that would, or would not, require planning permission. Maintenance and repair works, if carried out in line with good conservation practice and the guidance contained within this booklet, may not require planning permission. If an owner or occupier is in any doubt about particular proposed works, the architectural conservation officer in the relevant local authority should be consulted. However, if the structure is also included in the RMP, notification under the National Monuments Acts is always required, notwithstanding an exemption from planning permission.

For general advice on planning issues relating to architectural heritage, a publication entitled *Architectural Heritage Protection Guidelines for Planning Authorities* (2004) is available from the Government Publications Sales Office or can be downloaded from www.environ.ie.

WILDLIFE ACTS 1976-2010

Under the Wildlife Acts it is illegal to destroy (whether by cutting, burning, grubbing up or spraying) vegetation on uncultivated land during the bird-nesting season, that is between March 1st and August 31st in any year. While it may not be illegal to cut back ivy or other vegetation growing on a wall or other built structure during this season, best practice should avoid doing so if at all possible. Consultation with the National Parks and Wildlife Service (NPWS) of the Department of the Environment, Heritage and Local Government is recommended and may assist in decision making. While the unchecked growth of ivy can cause serious problems to a building, its benefit to wildlife, in particular to bees and birds, is immense and therefore where ivy is not causing problems it should be left alone.

Nesting birds and/or roosting bats are often associated with historic roofs and in certain circumstances it can be illegal to disturb them. While nests are commonly recognised on the external parts of buildings and bat roosts are often associated with intact roofs, both bats and birds can be found in small cavities in stonework such as exist in some masonry structures. If there is any concern that nesting birds or roosting bats may be present where vegetation is about to be cut back or removed; in a structure about to be repaired; or in trees due for felling, advice should be sought from the NPWS. Further guidance on dealing with bats in historic roofs is included elsewhere in this booklet.

SAFETY, HEALTH AND WELFARE AT WORK ACT 2005

Construction works, particularly to roofs, are potentially dangerous. When commissioning roof repair works, the owner or custodian of the structure should be aware of the requirements of the Safety, Health and Welfare at Work Act 2005 and the Safety Health and Welfare at Work (Construction) Regulations 2006. The duties of owners/clients, contractors and relevant professionals are mandatory under this Act and its accompanying Regulations. Helpful guidance is provided on the website of the Health and Safety Authority www.hsa.ie.

4. Identifying and Assessing Problems in Roofs

Roofing materials themselves are rarely the first to fail. The failure of the fixings, decay of battens, and water entering where flashings have lifted or gutters have dislodged, combined with poor maintenance

practices, are the primary causes of the problems associated with roofs. In addition, joints can open up over time at eaves level in stone or brickwork, allowing water to enter at the head of the wall.



This house has a particularly interesting roofscape, complex in form with several valley gutters and a series of slate-clad chimneystacks with plain clay pots. This type of roof is known as a gauged slate roof because of the use of courses of diminishing slate sizes from eaves to ridge, probably of imported Welsh slate. The ridges are covered in stone, bedded in lime mortar with tight joints. The character and appearance of the roof were

determined by the architectural style in fashion at the time; the consideration of weather conditions, such as the prevailing wind and driving rain; and the local, or readily available, materials used in its construction. A historic roof of this age and complexity will provide an owner or custodian with a range of issues and considerations at the outset of a roof repair project

Routine maintenance

Regular maintenance is vitally important, and historic roofs should be inspected and cleared of all debris at least twice a year. These routine inspections are an excellent opportunity to assess the overall condition of the roof covering, to see whether there have been any slate or tile slippages, flashings lost or lifted, water penetration to the attic space, or other such problems. See *Maintenance - a guide to the care of older buildings* in this Advice Series for further information.

Some areas will be accessible only when or if the covering is removed; this most detailed level of assessment should be carried out if particular problems need to be traced back to source. A roof should never be fully stripped for inspection unless it is absolutely clear in advance that the covering requires complete replacement. Otherwise previously unnecessary works will have to be undertaken as part of the assessment process: disturbed historic fabric and roofing materials damaged or broken during the stripping will require replacement.

A major difficulty with many older roofs is the lack of safe and easy access to inspect and to maintain the roof. This can be due to the height of the structure or the lack of trapdoor access, either into the attic space or onto the roof, to view or clean internal valleys and parapet gutters. If there is no existing access to roof valleys, an access point should be added when roof repair works are being designed. Planning issues can arise with the proposed insertion of access into roofs of terraced or multiple occupancy buildings, even into concealed valleys, as they could be a security or development issue for adjoining buildings or users. Access hatches into a roof space should be provided in less prominent areas which do not have decorative ceilings, such as in hallways or cupboards. Ideally, artificial lighting or natural lighting should be allowed for, so that the roof space can be examined on a regular basis to check for evidence of leaks or signs of decay.



In this close-up photograph of a roof with slipped slates, various short-term types of repair have been undertaken with differing degrees of success. Note the overlapping ridge detail, which is inappropriate to a historic roof

Inspection and survey

When considering roof repair works, the importance of good site survey work and research in advance cannot be over-emphasised. It is the primary basis for making appropriate decisions on the repair of a roof. With smaller, simpler roofs, it may be sufficient for the survey to be carried out by the roofing contractor. However, in larger-scale and more complex projects, independent professional advice is recommended to ensure best practice is achieved in assessing the cause of defects and specifying the methods to be used to repair them.

As with all conservation work, a survey should begin with a desk study to determine, insofar as possible, the age and evolution of the building. It may have been enlarged or altered several times, and it is often in the junction between two different parts of a building that problems first arise. Background research will also determine whether or not there are any surviving historical drawings or other documents available as a starting point towards understanding the building.

A comprehensive survey of the roof should be made, especially if it is to be altered. It is important to take photographs internally and externally at roof level, and depending on the extent of works needed, to prepare sketch sections from measurements gained within the roof spaces where access is possible. The information should be recorded on a survey sheet such as the one illustrated here. The completed sheet should be incorporated into a building maintenance file and regularly updated at the time of any roof inspections.

PROPERTY ADDRESS: Furze House Co. Laois		PROJECT REF: 312 FH
CLIENT'S NAME:		DATE OF SURVEY: November 2007
Location of building / roof in relation to main building:		Main Roof
Approximate date of building:		1720-1730s with late-18C addition to south-east
Type of roof (e.g. gabled, hipped, etc.):		Double 'A' with central valley and hipped ends
Area on flat, m ² : outer 306 m², valleys 151 m²	Pitch in degrees: 42 degrees	
Area on plane of slope, m ² : outer 412 m², valleys 203 m²	Rafter size and spacing: 115 x 80 mm @300 mm centres	
ROOF FEATURES		Rooflights: One access hatch; 2 no. dormers to valleys; 10 no. small glass panes light attic space
Chimneys: 3 no. rendered with concrete caps and ornamental pots. Note: valley gutter drains thro' two front stacks		Roof vents: None
Ridge: Dark grey, plain clay ridge tiles		Abutment / gable: None
Hips: Lead rolls over timber formers		Valleys: Polymer membrane over timber boarding; damaged and with inadequate falls
ROOF SLOPE & PERIMETER	Front, rear & hipped ends:	Inner valleys:
Original / non-original:	Mid-late 20C	Possibly original
Condition:	OK, but limited life span	Bitumen covered
Type of slate:	Cement, prob. asbestos fibre	Natural slate
Coursing:	255 mm high x 310 mm wide	Varies with random width
Size of slate:	12 x 24" (610 x 305 mm)	12 x 24"
Gauge:	250 mm	Varies
Number of slates (approx.):	5500	2,700
Colour of slate:	Dark grey	Grey/blue with green vein
Texture of slate:	Matt	Smooth & finely grained
Type of fixing:	Galv. nails	Wrought iron nails
Parging / membrane:	Bituminous membrane	Lime parging; very loose
Eaves / parapet detail:	Corbelled stone eaves / concrete	n/a
Rainwater goods:	Extruded aluminium	n/a

DIAGRAM

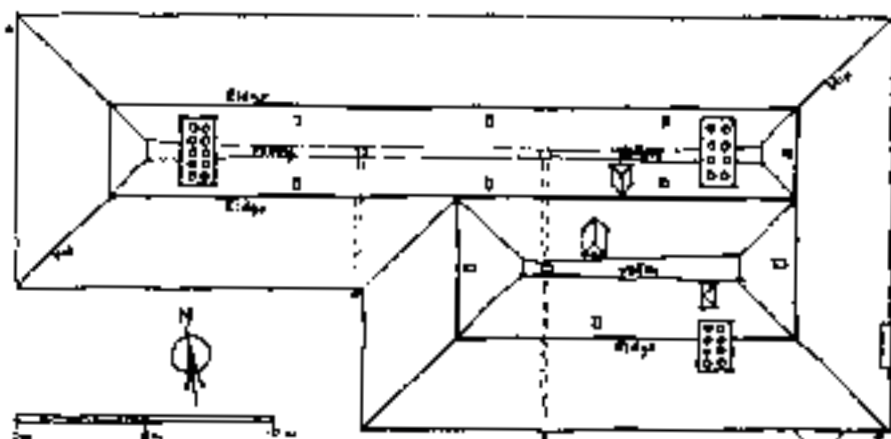

Additional notes:

2 no. lead-lined timber box with 1 no. piped secret gutter through roof

Sample survey sheet for the assessment of roof condition and record of detail

SURVEY OF ROOF STRUCTURE

A survey of the roof should be completed before carrying out repair or replacement works. This should start with an assessment of the roof structure:

- > What is it made of?
- > Is it structurally stable?
- > Is it in good condition?
- > Are there distortions and deflections?

The roof profile and the materials used in its construction and covering (including elements such as chimneystacks, roof dormers and lanterns) should be recorded.

The cause of any deterioration in condition will need to be determined. Particular attention should be paid to vulnerable areas where water is likely to penetrate into the interior of the building, for example at the ends of the rafters or at the flashings between the gable and the roof slopes and at the base of chimneystacks. It should also be established whether or not there is adequate ventilation of the roof timbers and whether fixings are corroded. Checks should be made for signs of fungal or insect attack in areas where ventilation is restricted, such as at rafter ends, behind parapets and around chimneystacks, and where pieces of lime parging may have fallen, blocking air flow between the rafters. The opportunity should be taken to inspect the condition of such items as water tanks, access hatches and lights, chimney stacks and aerials, as well as rainwater goods and outlets. Metal rooflights should be examined for signs of corrosion or distortion and for damaged cover flashings. Similarly, the structural stability of chimneystacks should be assessed; the capping or flaunching examined for cracks and lifted flashings replaced as soon as possible.

If the roof covering is to be fully or partially stripped, this provides an opportunity to inspect timbers in usually inaccessible areas around chimneystacks, below parapets and valleys, and along the head of the wall plate where it tends to be warmer and more susceptible to rot outbreaks.

STRUCTURAL APPRAISAL

In order to make an informed decision on what repairs are necessary, a detailed survey of individual timbers, their layout, spacing, sizes and condition should be carried out. Once this survey information is gathered, it will be possible to identify and locate rotten timber sections which need to be supplemented, treated or removed, and to locate where new timbers need to be scarfed or jointed into the existing structure. The aim of any repair work should always be to retain as much as possible of the existing historic timber and to supplement its structural capabilities where necessary.



These rafters were originally undersized for their span and had deflected, causing slates to lift or slip, and thus allowing water to enter the roof space. To correct the problem, this additional support structure was added during roof repair works

Identifying defects

The sagging or deflection of a roof should not always be diagnosed as a roof failure; some unevenness or undulation in an old roof can add to a building's aesthetic and historic character, provided it is not a symptom of ongoing structural instability and is not allowing water to enter the building. However, deflection which has caused the leading edges of the slate to tilt up or protrude is a problem once water penetration to the interior roof space occurs. In extreme cases, roof rafters can deflect to the extent of stressing the nail fixings and breaking the nail head through the slate. Defects of this type should be dealt with without delay.

DEFLECTION AND ROTATION OF ROOF TIMBERS

Sagging, rotation or distortion of rafters and ceiling joists can be caused by several different factors, including:

- > Rotting of the timber ends
- > Defects in the original design of the roof such as the use of overly long timbers without intermediate support
- > Increased loading on the original structure, for example, where a structure designed to carry a slate covering now has a heavier replacement concrete tile cladding
- > Insect or fungal infestation that has caused timber to soften and settle

Roofs, particularly those on extended linear-plan buildings, can suffer distortion in their middle sections. This distortion usually occurs due to wind suction where there is no bracing or bridging of the rafters, neither to each other nor back to the supporting structure. Sagging and rotational distortions should not always be regarded as a roof failure, as the roof can usually be strengthened by inserting additional timber strutting, bracing or bridging.

Where deflection is so serious that the roof covering has had to be removed, furring pieces (wedge-shaped pieces of timber fixed above rafters) may need to be added to even out the roof slope sufficiently to allow the covering to be successfully re-laid in a watertight manner. Similarly, new rafters can be fixed parallel to damaged or degraded rafters, providing a sound line to the roof profile.

Sometimes, movement in a roof may indicate a more serious problem with the support walls. If movement of the supporting walls is suspected, or if distortion has occurred in some of the larger beams or roof trusses, then a more extensive investigation of the main structural elements should be undertaken by a structural engineer with a knowledge of, and experience in, the repair of traditional structures.



The extent of movement in this roof truss is serious, indicating not only the poor quality of the original detailing but also potentially serious movement in the main supporting walls below

Timber decay

FUNGAL INFECTION

Timber roof structures are particularly vulnerable to decay where there is water penetration or poor ventilation. The continued unchecked ingress of moisture over long periods of time with little or very poor ventilation through the roof space will generally lead to timber decay. If the moisture content of the timber is allowed to remain above approximately 22 per cent, the conditions exist to make the timber vulnerable to insect and fungal attack.

Significant damage from water penetration may be first noticed on internal finishes, for example, discoloured and damp ceiling plaster. Localised investigation behind finishes or below valley or parapet gutters may be needed to assess the extent of the problem. However, wholesale removal of finishes should be avoided and temporary protection or re-laying of external valley linings should take place immediately after inspection.

Fungal decay is always associated with significant water penetration and once this has been combated, and the fabric of the building allowed to dry out, the fungus will die or become dormant. Conversely, the renewal of a water supply to the infected site is likely to reactivate the original rot outbreak. Therefore, ongoing monitoring of the affected area, coupled with regular maintenance of the roof covering and rainwater goods, are essential to long-term security.



Rot beneath this section of parapet gutter resulted in localised ponding of rainwater, exacerbating the problem and leading to wet rot damage to the truss end. Note that bonding timbers embedded further down the wall may also be affected by such leaks



Additional support was added on the diagonal below the truss end, thus avoiding the need for new timber splice and steel connections or the local removal of the rotten timber truss end. The timber that had supported the gutter above had to be fully replaced

WET ROTS

The term 'wet rot' is generic and actually refers to numerous different fungi which are still being identified. Wet rot is more common in roofs than dry rot and may be found in the ends of rafters, ceiling joists and timber wall plates at the eaves, valley or parapet gutters where timber is in contact with damp masonry. Likewise wet rot damage is frequently found where timbers abut, or are supported by, masonry gable walls and chimneys such as purlins or trimmers around chimneys. Parapet gutters and valley gutters are also particularly vulnerable. Frequently, the areas affected by wet rot damage are in those parts of the building where access for regular inspection of the roof is difficult.

Timber affected by wet rot loses its integrity and becomes soft and friable. It is often accompanied by a musty smell and sometimes fruiting bodies or fungi can be seen. Seriously affected timber needs to be replaced or have strengthening timbers laid alongside, but timber with only localised rotted areas may be repairable by removal and replacement of the decayed portions with sound timber. Timbers which are damp but show no signs of decay should be dried out to a moisture content of approximately 18 per cent or below to avoid the risk of subsequent decay. In some poorly ventilated areas within a roof where drying time cannot be reduced to less than about six weeks, the application of a paste treatment containing a fungicide may be appropriate. An independent timber treatment specialist should be asked to advise on treating rot.



Evidence of wet rot damage to a roof beam and rafters under a tapered valley gutter. Only about ten per cent of the beam section was degraded, so no strengthening works were required to the beam. The rotted rafter ends, however, needed replacement



A new steel support bracket has been supplied to support this roof beam severely affected by wet rot at a chimney breast. The chimney flashings above, which had failed, were also repaired as part of these works

DRY ROT: SERPULA LACRYMANS

Dry rot is less common in roofs than wet rot; nonetheless it can, in some instances, cause serious problems. Dry rot requires damp, humid conditions to thrive. The name 'dry rot' is misleading as this fungus will survive only where timber moisture content is in excess of 20 per cent. An advanced outbreak of dry rot is easily distinguished from wet rot in that it produces an abundance of white mycelia – a fluffy mass of cotton wool-like threads. Mature fruiting bodies are rust red in colour and rust-coloured spore dust on nearby surfaces can be an indication of its presence. Timber that has been the subject of dry rot attack will have lost its structural integrity and look as if it has been formed in separate cubes with cracks running across the grain. This cuboidal cracking is a distinctive characteristic of dry rot infected timber.

The conservative method of treating dry rot concentrates on removing the source of water and improving levels of ventilation to the roof space. This is known to halt the spread of dry rot and leave the fungus unable to thrive and reproduce. Leaking flashings and gutter linings should be repaired and appropriate pointing or rendering carried out to adjoining masonry. The removal of timber affected by dry rot should be limited to that timber which is structurally decayed and any small remaining parts that need to be removed to allow a structural repair. There is no need for wholesale removal of sound timber in an area of dry rot outbreak, nor is extensive chemical irrigation of masonry adjoining the outbreak always advisable, due to the toxic nature of some products and the need to avoid introducing more moisture into the fabric of the building. New timbers used in repair works should be pre-treated and isolated from masonry by wrapping the ends in a damp-proof membrane. Local fungicidal treatment of the timber immediately surrounding the rot outbreak may be appropriate to prevent future outbreaks. This treatment will need to be of a deep penetrating formulation, or else injected into pre-drilled holes in the timber. An independent timber treatment specialist should be consulted to advise on appropriate action.



The fruiting bodies of the serpula lacrymans fungus can be identified by their rust or orange colour, usually with a white edging

INSECT INFESTATION

In Ireland, there are four types of insect capable of maintaining an infestation in building timbers. These are:

- > Furniture beetle (commonly known as 'woodworm')
- > Wood-boring weevil
- > Death watch beetle
- > House longhorn beetle

The last two species are extremely rare and have only been found in a handful of buildings in this country.

FURNITURE BEETLE OR 'WOODWORM' (ANOBIUM PUNCTATUM)

The furniture beetle can be a serious pest in building timbers. It lays its eggs in crevices in the sapwood of both hardwoods and softwoods. The larvae hatch within weeks and spend the next few years (between one and five years, depending on conditions) burrowing through the sapwood of the timber. The larvae then make their way back up to just below the surface of the timber and form a pupal chamber. They pupate for about eight weeks. The adult beetles emerge between late May and August. Active furniture beetle infestation can be recognised by the presence of sharp-edged 1 to 2mm diameter emergence holes with interiors the colour of freshly cut timber and fresh wood dust. Particularly in the summer months, dead beetles 5 to 6mm long can be seen near or on affected timbers.

The burrowing larvae cause damage by eating the cellulose in the timber and leaving the remaining structure in a weakened honeycombed state. The furniture beetle prefers wood that has a moisture content of above about 12 per cent, which unfortunately includes the timber in most roof spaces. Furniture beetle almost exclusively attacks the sapwood rather than the heartwood of any timber element. Hence in oak construction, and many of the earlier softwood roofs, the extent of damage is limited, as the amount of sapwood left on the timbers was minimal. The exceptions to this are timber boarding, such as that used in valleys, and roofs constructed of unwrought timber members, as were sometimes used to make vernacular thatched roofs. The percentage of sapwood in these timbers is usually high and the extent of damage caused by the furniture beetle may be of greater significance.



Furniture beetle has damaged only some of the faces of these timbers – these are the sapwood faces of ceiling joists. The slight shrinkage of the joists where they are mortised into the ceiling beam was not seen as problematic in this case but, if the displacement were any greater, it would need thorough investigation

Where furniture beetle damage is found in twentieth-century roofs, it is likely to be more extensive and of greater structural significance, as the timber used in these buildings came from managed plantations that were harvested after about only 50 years of growth and so contain large amounts of sapwood.

A simple rule of thumb is that if there is active furniture beetle and there is any extent of sapwood present then treatment will be required. Where possible, the treatment should be localised to the area of outbreak. Within roofs the treatment should be in the form of a spray or brush treatment of all accessible wormed surfaces with a spirit-based preservative containing a contact insecticide. It is possible to kill furniture beetle by heating the entire building fabric slowly to 55°C whilst maintaining constant humidity throughout the fabric. However this remedial process is suitable for museum-standard conservation projects only.

WOOD-BORING WEEVIL (EUOPHRYUM CONFINE / EUOPHRYUM RUFUM)

The wood-boring weevil attacks only timbers that have been modified by fungal decay and thus it can be regarded as a secondary pest. It attacks all types of timber and plywood. The emergence holes are about 1mm diameter and the adults are between 3mm and 5mm in length. The adults can be found all year round and can be distinguished from the furniture beetle by their cylindrical body shape and elongated head. The insects are attracted to light and so quantities of dead weevils on window sills can indicate the presence of concealed wet rot decay.

DEATH WATCH BEETLE (XESTOBIUM RUFOVILLOSUM)

The death watch beetle is so called because of the superstitious belief that the tapping noise they produce with their heads was an omen of impending death. The death watch beetle predominantly attacks decayed oak or other timbers where an infestation in the oak has already occurred. Because of the lack of surviving oak in Irish roofs, the death watch beetle has been identified in only four buildings in Ireland to date, all of which are located in the Dublin area.

HOUSE LONGHORN BEETLE (HYLOTRUPES BAJULUS)

The house longhorn beetle predominantly attacks timbers with a high moisture content, usually green or unseasoned timber. Few outbreaks have been associated with seasoned timber within buildings and these infestations were usually associated with timber rot. To date there has been one known Irish case of house longhorn beetle infestation, discovered in the timbers of a building in County Antrim.

Treatments of timber

Timber treatments involve the application of chemicals and insecticides. If used indiscriminately they may kill off many of the natural predators of furniture beetles and weevils, such as spiders, and adversely affect bats, which are a protected species. Excessive use of such chemicals may also have an adverse impact on the health of the occupants of the building.

It is important to get expert advice when an outbreak of fungus or insect attack is discovered in a building. The advice should be independent, preferably from someone who is not trying to sell a particular product or treatment method. Any treatment of a fungal attack should include a detailed examination of the building to locate and deal with all sources of water penetration. Modern dry rot treatments recognise that these fungi are living organisms that will die off naturally, as any plant would, if the environmental conditions that support them are removed. Removing the source of water and supplying good ventilation will kill off the fungus. Keeping the building dry will prevent it re-establishing.

An owner or custodian of a historic building should be very cautious about proposed treatments that require the removal of large amounts of timberwork within a certain radius of the fungal infection. It should only be necessary to remove timber which impedes the works necessary to stabilise the structure or to reinstate finishes.

ASSESSING THE EXTENT OF TIMBER DAMAGE

The extent of timber damage caused by fungal or insect infestation can be initially assessed using simple tools such as a bradawl or sharp screwdriver pushed hard into the damaged timber by hand. The extent of unsound timber can be easily judged as the depth the spike enters before resisting moderate hand pressure. Where damage is extensive, or where there are large structural timber members present, the extent of damage will need to be assessed by an independent specialist who can make accurate assessments of the extent of damage to all the timbers, as well as using modern techniques such as microbore drills to check deep into larger timber members, particularly at their bearings. If the extent of damage is severe, then a structural engineer with experience in the repair of traditional structures will be necessary to design and specify the strengthening works required.

DEFRASSING

Defrassing is a term used to describe the removal of degraded material from timber that is badly damaged by insect or fungal infestation. This process was promoted in the latter part of the twentieth century as a method of assessing the amount of timber of sound structural integrity remaining. Defrassing should not be used on historic timbers. The process removes all historic timber marks such as adze marks and the possibility of accurate dating from growth rings is reduced. Localised removal of damaged timber to allow a structural repair to good sound timber is of course acceptable.

Problems arising from previous inappropriate repairs

The external roof slopes may have been painted with a bituminous liquid, either on its own or with a hessian base, as a 'quick fix' to resolve slate slippage and leaks. These types of repair essentially stick the slates together and make it impossible to carry out local repairs. If this treatment, known as 'turnerising', has been applied to a roof and there are further leaks, complete replacement of the slates is the only option. Furthermore, slates subjected to turnerising are not fit to be salvaged and reused.



The process of covering a leaking slate roof with a bitumen covering was known as 'turnerising.' It is ineffectual and damaging and should never be carried out on a historic roof. Furthermore, it prevents the slates ever being salvaged for reuse

The pitch coating, used on its own, melts and gravitates toward the lower part of the roof. If hessian is used with the bitumen it is more stable on the roof than the liquid coating on its own but nonetheless has a negative effect. Furthermore, such treatments cause greater heat and humidity to build up in the newly sealed roof spaces. The ability of the roof to ventilate properly becomes compromised and this allows higher levels of condensation to build up. This will make the roof timbers more vulnerable to insect and fungal infestation, particularly in buildings with high occupancy levels, as the moisture content of the trapped air in the attic interior will be higher.

This series of drawings describes how local repairs to a slate roof can be carried out:

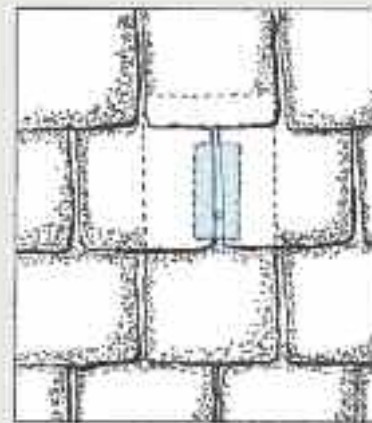

The 'bib' repair, which is used to re-affix a slipped slate



Here, a partially folded metal piece is slid under the upper slate as part of the bib repair. The metal is partially folded to allow the metal to sit above the nail head. The metal used should preferably be a painted aluminium or copper but should be matt in texture

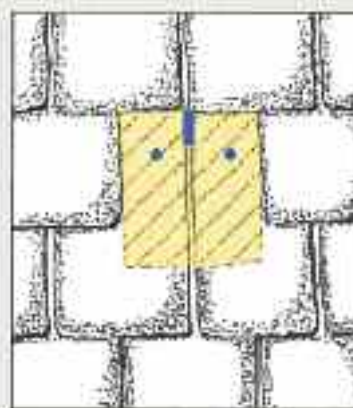

The slipped slate (in yellow) and the areas most likely as a result to spring a leak (in blue): the nail holes and the top of the joint

Problems associated with nailing

Nail holes are punched from the back of the slate so that the front of the hole is knocked out, thereby becoming bevelled and allowing for the nail head to sit into the slate. Both 'under-nailing' (leaving the nail head protruding where it will rub against the overlying slate) and 'over-nailing' (where the nail head breaks through the nailed slate) will adversely affect the longevity of the roof covering.

NAIL SICKNESS

The principal defect in many older roofs is the failure of the iron nails used to fix the slates, eventually leading to wholesale slippage of slates. This condition, commonly known as 'nail sickness', occurs in a roof where the nail shank has worn away beneath the head due to wear on the fixings or from corrosion in urban areas. Inadequate or worn fixings cause rattling of slates in high winds, which may further erode the nail hole. The easiest way to spot slipped slates on a gabled roof is to set a ladder against the gable and look along a slate course. Any slate which is 10mm lower than all the others (this can be judged from the weathering on the slate face) indicates nail failure.

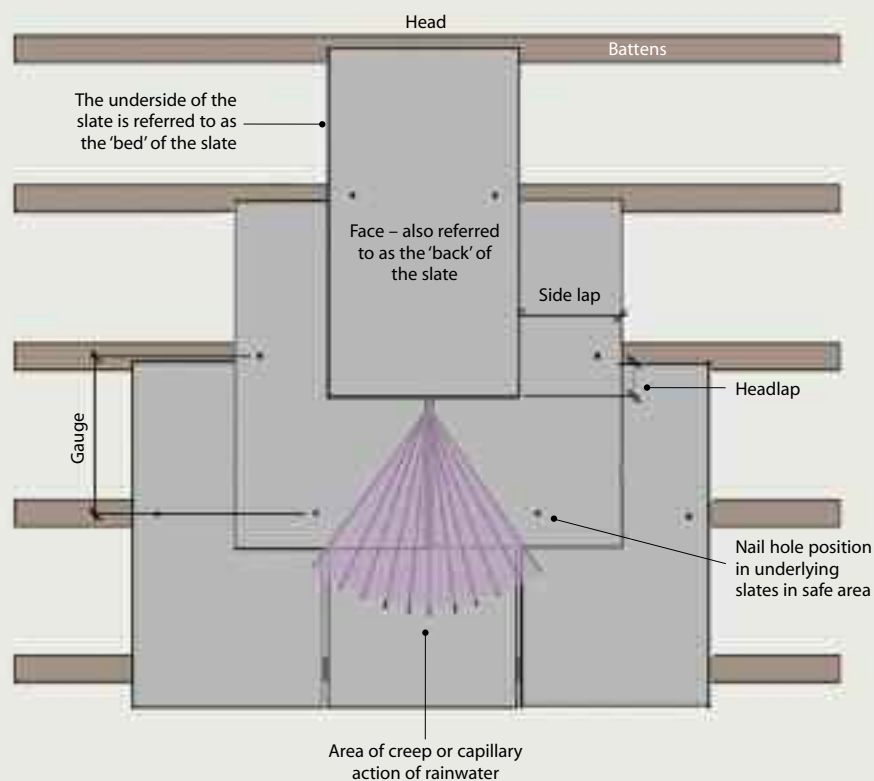

This drawing shows the terms relating to a slate and its fixings and illustrates the main area of water run-off on a double-fixed slate. If this area is cracked or holed or not adequately lapped, this will most likely be the area in which a leak will occur. If a leak occurs in the area called the headlap by way of a crack, it can be very difficult to spot, as the overlying slate conceals it from above and the

lime parging (where it exists) conceals it from beneath. Smaller slates are required to be laid at a much steeper pitch and, due to the increased number of fixings, there is more opportunity for leaks. This is why, historically, it was common to find the lowest slate course on the roof larger than those on the main body of the roof

Slate decay

Typically it is the nail fixings and/or the battens that decay and fail, not the slate itself. However, in highly industrialised areas or urban centres deterioration and delamination in natural slate caused by atmospheric pollution can become apparent. Delamination may occur on the top layer of a thick slate but, when scraped clean, the slate beneath is still sound and suitable for use; although the surface may appear unsightly (a slightly damaged appearance should be tolerated as the alternative to having to replace the slate). As rainwater tends to be held between slates, the degradation of slate may be evident only when the slates have been stripped off. Pollution damage generally occurs on the covered portion of the slate, as the margin (or tail) of the slate is exposed to rain which keeps it clean. A poor quality slate containing carbonates can react to sulphur in rainwater, making the slate porous, in which case replacement of the slate is the only option.

Faults from the use of incorrect sheet sizes

Serious and extensive failures may occur in lead-sheeted roofs due to the original use of overlarge sheets or the use of too light a code of lead. Alternatively, the problem may be the result of the fixing of the sheets at points too close together, that restrict the natural movement of the lead due to thermal expansion. If no underlay (a thin sheet of building paper or felt) has been fitted between the boards or decking and the lead above it, this can result in the lead sticking to the boards and causing the lead eventually to split, particularly if the timber is resinous. Some building papers have a bituminous core which can leak, sticking the lead to the timber. Felt used underneath lead should not contain bitumen. The symptoms of oversized or over-fixed sheets of lead are ripples or splits in the sheet, which denote crystallisation or metal fatigue. When the sheets split, rainwater can enter through the roof covering and cause extensive damage to the timber beneath. These detailing faults are often accompanied by inherent design faults in the slopes and steps in gutters. Before repairing or replacing the lead to the existing roof, a

full assessment of the plan, the gutter falls and number of rainwater outlets should be carried out. Frequently, redesign of the gutter layout and falls will be required and modifications will be necessary to the sheet sizes or codes used, or the distance between fixing points.

Insufficient ventilation

Poor or inadequate ventilation in older roofs is generally not an issue. Ventilation problems occur mainly with the introduction of new materials or with any modification of the roof form which removes existing ventilation routes. Historically, lower heating regimes in buildings coupled with the presence of breathable building materials allowed the structure to self-regulate and to avoid excessive moisture build-up. In buildings which accommodated large numbers of animals or humans, high-level metal or timber vents were incorporated into the roof covering to deal with the greater levels of moisture within the building.

The negative impact of reduced ventilation in combination with increased insulation can be further aggravated when the use of the building changes or an enhanced heating regime is introduced. When the use of a traditional material such as lime parging (which has a natural ability to absorb a certain degree of condensation moisture and release it over time) is replaced with a non-breathable roofing felt, problems arising from trapped condensation can appear similar to a leaking roof.

Bats and historic roofs

Bats frequently roost in roof spaces and other parts of buildings. They may be found under the slates, hanging from roofing felt, parging or timbers, and in joints and splits in roof timbers. Bats do not pose any significant threat to the fabric of a building nor to the health of its human occupants. Bats are usually only present in the roof space for part of the year but, as they tend to return to the same roosts every year, the roosts are protected whether bats are present or not.

Bats and their roosts are protected by Irish and EU legislation. The Wildlife Acts make it an offence to wilfully damage or destroy the breeding or resting place of a bat. Even where planning permission has been granted or works to a roof are considered exempted development, the requirements of the Wildlife Acts still apply.

When considering any works to a historic roof, the first step is to have a bat survey carried out by an appropriately qualified bat expert. Where bats are present or there is evidence that they have used or are using a roof, the National Parks and Wildlife Service of the Department of the Environment, Heritage and Local Government should be contacted for informed advice and guidance before any roofing works are programmed and initiated. If there is an active bat roost, works will need to be programmed to cause the minimal amount of disturbance, and measures put in place to allow bats to continue to use the roof space upon completion.

The most common and effective method of minimising the impact of roof repair works on bats is to carry out the work at an appropriate time of the year. The great majority of roosts in buildings are used only seasonally, so there is usually some period when bats are not present. Maternity sites, which are the ones most often found in roof spaces, are generally occupied between May and September, depending on the weather and geographical area, and works should therefore be timed to avoid the summer months.

Larger re-roofing projects, however, may need to continue through the summer. The best solution in such cases is to complete and secure that part of the roof that is the main roosting area before the bats return to breed. If this is not possible, work should be sufficiently advanced by May or June for returning bats to be dissuaded from breeding in that site for that year. In this case, alternative roosts appropriate to the species should be provided in a nearby location. Another possible solution is to divide the roof with a temporary barrier and work on one

section at a time so that the bats always have some undisturbed and secure areas. The advice of a bat expert should always be sought, and there may be a requirement for this expert to be present on site during the course of the works.

Where it is proposed to treat roof timbers against fungal or insect attack, careful consideration must be given to ensure that the treatment used will not adversely affect the bats.

Where roofing membranes are to be included as part of re-roofing works, they should be of a type that allows bats to hang from almost any point. Plastic membranes are mostly unsuitable because bats have difficulty hanging upon these, so wind-break netting stretched beneath the membrane should be used.

The completed roof should be accessible and amenable to the returning bats. Access to the roof space can be provided in a variety of ways, including the use of purpose-built bat entrances. Bats also need suitable roosting sites and an appropriate temperature regime. This can be provided by the construction of a bat-box within the roof space that has the advantage also of providing some segregation between the bats and building's occupants.

For further information, see the National Parks and Wildlife Service publication *Bat Mitigation Guidelines for Ireland* (2006) which can be downloaded from www.npws.ie.

5. Repairing a Historic Roof

Timber structural elements

Repairs to a historic roof should retain its structural integrity and historic significance. The aim of repair should be to minimise the intervention in order to retain as much as possible of the historic fabric of the roof. The use of traditional materials, techniques and carpentry details is generally preferable, as these keep the integrity of the historical detail and do not detract from the character of the building. Simple repairs such as inserting a new timber alongside a damaged rafter or ceiling joist, or splicing in new timber pieces, can be easily carried out using readily available materials and carpentry skills. However, it should be borne in mind that traditional repairs such as the scarf joint have limited structural performance and require skilled craft labour to implement properly. If original material must be removed to make the repair, then the extent of fabric to be removed should be guided by a skilled practitioner. Traditional carpentry repairs should be properly labelled or recorded to alert future generations to the date of the repair. Introducing a new structural member to reinforce the existing historic structure, or even take over the structural function of the original roof timbers, should not necessarily require the removal of the failed original timbers.

Repairs to existing structures employing contemporary materials, techniques and details should respect the significance of the historic timber structure and not cause damage to it. The repairs should not impede future research into the roof nor conceal significant details or features.



The use of a traditional scarf joint repair to damaged rafter ends is particularly worthwhile where the roof structure is exposed to view (Image courtesy of the Irish Georgian Society)

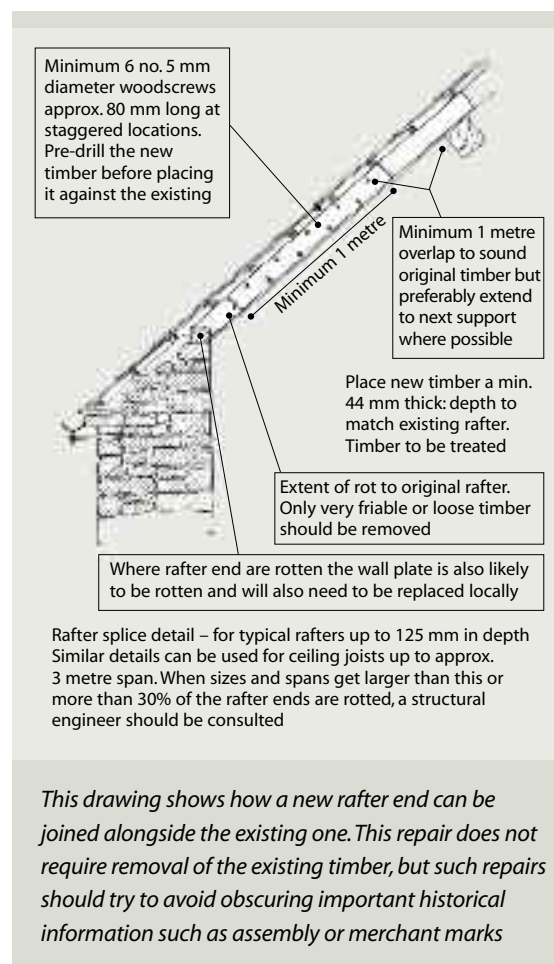

CHOOSING THE RIGHT TIMBER FOR REPAIRS

The choice of timber to be used for repairs is of critical importance. A match in timber type should be obtained, for instance oak for oak and red deal for red deal, so that the physical performance and structural capabilities of the timber are compatible. It is equally important to keep the use of sapwood to a minimum as it is more susceptible to insect infestation. Sections of timber need to be carefully selected, and may even need to be cut from larger baulks of timber and trimmed down to size to remove all sapwood. As new timber is often placed in an area previously affected by timber decay, fungicidal or insecticidal pre-treatment of the timber should always be considered and only omitted if there is a good reason for doing so. New timber should not be placed in direct contact with damp masonry, but should be isolated from it, either by supporting the timber on new brackets away from the wall or by placing a damp-proof layer between the timber and masonry.



Added support has been given to the main hip roof truss at an internal valley. This repair detail used prefabricated steel elements and tooth plate connectors, but avoided the need to open up the recently repaired valley finishes and does not obscure the original truss details



Two consecutive corrective structures to provide additional support to undersized ceiling joists. The first intervention (upper left) occurred early in the roof's history and consisted of the addition of a timber beam and timber hangers to give extra support to the ceiling joists. The new beam itself then deflected. Further corrective measures were taken using a new steel beam (lower right). Note that all original timbers were retained intact and the history of the roof and successive repairs can easily be read

OTHER REPAIR MATERIALS AND TECHNIQUES

Where necessary, more extensive repairs can be made using modern mechanical fasteners such as tooth plate connectors, split rings and steel brackets. These can produce a detail whose function is readily apparent and calculable by current engineering standards and which is theoretically reversible. Introducing a new structural member to reinforce the existing historic structure or even supersede it is often a viable option and can usually be designed to avoid the removal of the failed original timber.

The use of other more specialist repair techniques, such as resin-fixing steel or carbon fibre plates to existing timbers, or fixing plates or tensile rods within the timber, requires specialist knowledge and expertise in their design and specification. These repair techniques are not reversible and their long-term performance is as yet unknown. However, in certain instances one or other of these methods may allow more retention of historic fabric and be visually more acceptable than any other available method. The use of these techniques in a historic roof will require the advice of a structural engineer experienced in the repair of traditional buildings.



Ferrous metal roof structures should be regularly checked for corrosion, particularly at supports and where built into potentially damp masonry. Where there is significant corrosion of the ironwork, the masonry is likely to crack, as the products of iron corrosion (rust) are approximately eight times the volume of the iron itself

Roof details

ROOFLIGHTS AND DORMERS

Frequently, access to the exterior of a roof via a cast-iron rooflight was provided for maintenance purposes and these rooflights can be difficult to open or lift due to their weight and design, and may now be considered unsafe for use. Lack of regular painting eventually leads to the deterioration of the hinges but they can be repaired and put back in working order. Where no roof access is provided, the provision of safe and permanent access for maintenance purposes should be considered where it can be satisfactorily achieved. There are several products on the market suitable for most conservation projects. They are designed to be more streamlined with the roof covering, using a lower upstand in comparison to the more substantial and more obvious modern rooflights, which have larger glazed areas and profiles.

Sometimes single sheets of glass were fixed into the surrounding slate as a means of bringing natural light into the attic space. These glass panels tend to be poor at protecting against water ingress. Fitting a well-detailed, strategically placed, contemporary conservation-type rooflight in a central valley would allow the introduction of natural daylight to the attic space. The installation of new elements should be in



There are several contemporary products available, of which the side-opening rather than top-hung skylight type is possibly the most convenient for providing access for maintenance inspections of the roof

accordance with statutory requirements and should not compromise the character and finish of the historic roof.

Where pitch-roofed dormers survive, they should be retained and repaired on a like-for-like basis using similar slate or lead covering details.

CHIMNEYS AND FLUES

Due to their exposed position, chimneystacks often experience the worst effects of the weather and are vulnerable to decay and structural failure.



Chimneystacks are prominent features and add considerable character to a historic building. They are integral to the design as well as to the original use of the structure and, even when redundant as vents for fires, play an important role in providing ventilation to the interior of a building

Chimneystacks should be inspected regularly, especially if there are any concerns about structural integrity. Roof rafters and trimmers either side of a stack should be investigated for water damage if the fabric of the stack has noticeably deteriorated. It may be advisable to have a professional carry out a thorough visual survey and use testing apparatus where necessary to identify flue defects. Flues can be surveyed using a camerascope, and tested with smoke pellets which are available through plumbing suppliers.

Constant saturation and frost action can severely undermine the structural integrity of a masonry chimney, particularly if there is any loss of mortar or spalling of bricks (the surface of the brick detaching). It is important that chimney flashings be inspected and defects remedied promptly. A common flashing detail evident in Dublin at roof level is the use of slates bedded in lime to protect the chimney or the masonry abutment. Where these cut-slate flashings have been lost or damaged, the original detail should be repaired, bedding the slate in lime.

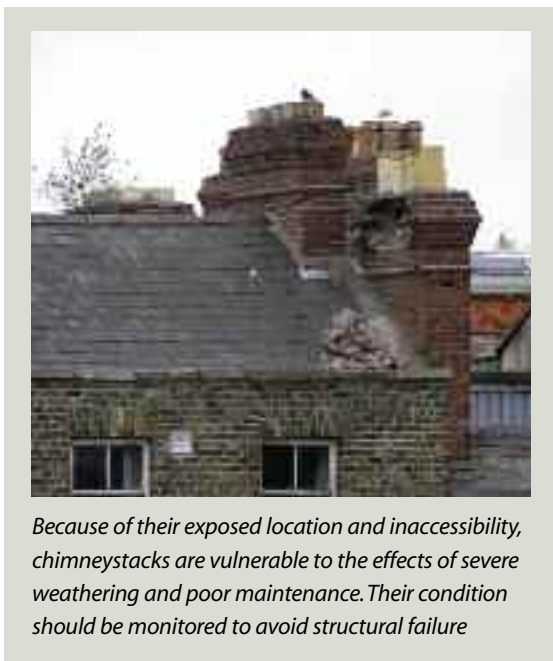

Because of their exposed location and inaccessibility, chimneystacks are vulnerable to the effects of severe weathering and poor maintenance. Their condition should be monitored to avoid structural failure

Water penetration through damaged or lost stone copings or flaunchings (the profiled fillet between the coping and the chimney pot) can cause considerable damage to the top courses of a masonry stack. Flashings commonly crack where damage is caused by movement in the masonry. On brick chimneys where the brickwork has distorted and the mortar joints have eroded, the lead or copper flashings may become detached.

Shared stacks should be inspected and any structural defects addressed as a priority. This is best dealt with with the cooperation of the adjoining owner, as a damaged or cracked stack can affect both properties. Sometimes, in mud-walled structures, chimneystacks are built from brick set on top of a rammed earth chimneybreast comprising a large hood at fireplace level and supported by a large timber beam through the upper floor level. In all cases, careful inspection will be necessary to determine the nature of construction and the condition of any timbers adjoining the flue or

stack. Infrequently, fireplace hearth slabs were built directly on top of joists, which can cause charring within the floor structure and is of particular concern in historic structures with thinner hearths. Old charred timbers are susceptible to catching fire within, or adjoining, flues and their condition and location need to be ascertained within redundant fireplaces or flues if they are to be reused. If there is evidence of a past chimney fire it is quite likely the condition of the flue will need to be investigated further, and relining may be necessary.

The installation of television aerials and satellite dishes to chimneystacks can cause problems, as extra pressure and movement is exerted on the structure in windy conditions. Where possible, alternative locations for such installations should be sought and no new aerials or dishes fixed to historic chimneystacks.

Previous inappropriate repairs to damaged chimneystacks may be the cause of problems, such as tying the stacks with metal straps or applying a coating of cement render. Problems will arise as the cement render, in time, will crack allowing water to saturate the softer brick or stone beneath. As cement renders are impermeable, they prevent the drying out of the masonry, causing further deterioration of the stack. Superficial examination of a chimneystack repaired in this way may suggest just minor cracking in the render. However, removal of the metal strapping and cement render will usually reveal greater structural damage beneath.

Stacks and pots should not be removed, even if they become redundant. Redundant flues should be properly capped and ventilated. Ventilation can be achieved using a vented pot or brick to the flue, venting to the external air and not into the attic, and also at fireplace level, to ensure airflow sufficient to keep the stack dry.

A damaged fin wall separating a flue, if dislodged, can fall into adjoining flues and cause a blockage. Telltale signs that this failure has occurred include smoke rising from more than one chimney pot when only one fire is lit, or by smoke leaking into an adjacent room or even into an adjoining property.

From about 1900 onwards, the insertion of chimney trays into brick stacks became standard building practice. A chimney tray is a lead tray inserted at roof level into a chimneystack, forming a barrier to moisture ingress. In combination with a DPC below the coping and with flashings at the base of the stack, water is prevented from passing through the brickwork and entering the attic space.



Vented pots



Many older flues have little more than half-brick fin walls called 'feathers' within the stack separating the flues from each other. These can be poorly tied in or even entirely missing as the result of chemical attack from soot, heat damage or over-vigorous cleaning with soot brushes

On rare occasions, a chimneystack may be eroded or damaged to the extent that it presents a public safety issue or would damage a roof should it collapse. In such cases, following expert advice, it may be necessary to dismantle and rebuild the chimneystack. Prior to dismantling, a full photographic and measured survey should be compiled, with all decorative features and profiles recorded to aid the accurate reconstruction. Depending on the level to which the chimneystack has to be taken down, the insertion of a DPC tray should be considered when reconstructing.

CHIMNEY POTS

Chimney pots suffer similar exposure and weathering to chimneystacks. They may sometimes be too damaged to successfully repair and, in such cases, should be replaced with new pots of a matching design, as they are important visually and provide ventilation to redundant flues. Many traditional designs of chimney pots are still widely available.



The use of wire crow guards prevents birds from nesting in chimney pots, but does not stop plants rooting in blocked flues

Where more than one fireplace gather to combine into a single flue and one flue only is to remain in use, then all adjoining flues should be sealed off. An alternative solution, dependent on there being sufficient space available within the original flue, is the installation of additional liners for the fireplaces. The choice of flue liner will depend on the following: the opening required within the room; the route and size of the existing flue; and the fuels proposed to be used in the fireplace/stove. The redundant flues should be vented wherever possible.

In predominantly straight flues, a slate shelf was sometimes incorporated within the flue. This shelf was installed so that rain did not fall directly onto the fire. Unfortunately, within a disused flue this shelf tends to gather debris, soot and the material from birds' nests.

FLUE LINING

Many flues were constructed of stone or, more generally, well-fired brick, finished out with lime, which from the 1960s onwards was superseded by the use of ceramic or clay flue liners as the standard construction details. The insertion of clay liners into the flue prevents the worst effects of the hostile sulphate environment on the masonry within the chimney. Most old flues are sufficiently large in size, and if they are to remain in use, the installation of liners should be considered as a precautionary measure, particularly for chimneys on gable walls where the outer skin of the flue is exposed to greater environmental extremes. If the chimneystack has not been in use for a while, the brickwork in the flue can be in poor condition. This occurs when moisture acts on the sulphate content of soot deposits and converts it to an acid, which is capable of eroding the bricks. Damaged bricks should be carefully removed. Sulphate-damaged brick should not be used in reconstruction work. Solid clay bricks should be used for repair purposes. The stack should be consolidated internally to prevent the escape of flue gases into the roof space, and lime-rendered externally, where appropriate, to improve weathering.

There are several ways of lining a flue. Most methods are carried out by specialist companies. If the flue is straight and sufficiently short in height, a stainless-steel double-lined flue can be installed within the existing flue. In this method, short sections of pipe are fitted to one another. The second method is to use lightweight pumice liners with joints sealed at each section of liner. The sections of liner are fitted from the roof top and require the chimney pot to be temporarily removed. Access is also required internally at the base of the chimneybreast. At the base of the flue, support is needed to hold the flue liner and the insulated backfill in place. It can take the form of a concrete gather or an aluminium plate (depending on the proposed use of the flue).

A third choice, a flexible stainless-steel flue liner, is probably the simplest to install and can be used if there are many bends in the masonry flue. Access points have to be made at the change in direction of the original flue to ensure the proper installation of the metal tube. This may be unacceptable where there is a fine interior. There are two flue liner options of this stainless-steel type. The first type, which is for use with a gas appliance, is a single-skin construction. The second is a spirally wound double skin made of stainless steel with a smooth inner surface which is particularly resistant to corrosion and can be used for all fuel types.



Flexible stainless steel flue being inserted into a historic masonry flue

If an existing flue is required to serve a gas boiler, it will require a flue terminal at roof level and the flue to be lined (approved by the utility provider) because of the higher temperature omissions. These stainless-steel terminals can be unsightly, though there is also a terracotta gas terminal available which may be suitable in some situations. If the visibility of the terminal location is an issue, consideration should be given to an alternative location for the boiler flue or the use of a balanced flue (a horizontal flue combining air intake and extract at low level through a wall).

PARAPETS

Parapets were designed to conceal the exposed roof slopes from view. There are inherent difficulties with parapets arising from construction methods, including poor tying-in to the structural walls and high levels of exposure. These difficulties are often worsened by their inaccessibility and the consequent lack of maintenance, giving rise to the potential for serious water penetration and deterioration of the fabric. For further information on the repair of brick parapet walls see *Bricks – a guide to the repair of historic brickwork* in this Advice Series.

A typical Georgian parapet detail: with the introduction of larger slates in the eighteenth century, roof pitches became shallower and architecturally more subservient, hidden behind parapet walls

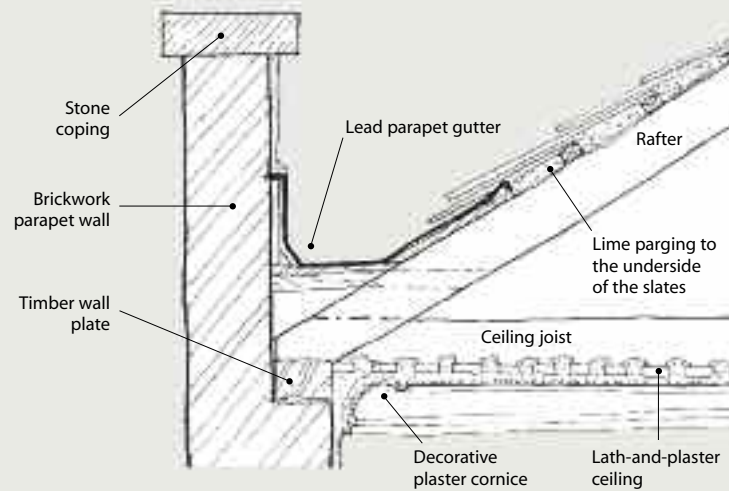

The use of lead flashings to parapets in excessive lengths that deteriorated, cracked and split under pressure from thermal expansion has resulted in water soaking into parapet walls and main walls below, often causing deterioration of the bearing ends of roof trusses, beams and joists.

Parapet repairs which are not well planned or executed and which use inappropriate materials are a false economy and may have a detrimental impact on the historic structure. Frost action and weathering effects are other potential agents of decay in the parapet structure. The wrapping of parapets in felt or other torched-on products leads to the retention of water within the parapet fabric, where it can cause decay. These torched-on products may fail on lengthy exposure to ultra-violet light and the effects of heat build-up. The use of torching is not generally recommended on historic buildings because of the fire hazard it creates. When carrying out repairs to a parapet, the opportunity could be taken to install slate, lead or copper coverings or claddings. Such claddings should be affixed to the rear face of the masonry upstand, dressed soundly to the parapet valley and to the damp-proof course below the coping. The use of the same cladding material for both parapet gutter and upstand is recommended. In terraced structures, it is necessary to ensure that any repair work is compatible with the neighbouring parapets and that problems will not arise at the junctions of masonry, claddings or flashings.

Lead has been found to corrode in contact with lime, typically where lead is used as a damp-proof course below weathered coping stones on a parapet. To avoid this problem arising, the lead can be protected with a coat of bitumen paint before being installed.

Where slate was used historically to clad the full rear face of a parapet wall, this detail (traditionally using large slates such as Kings or Queens) should be recreated where possible, using lime mortar to bed the slate.

In the case of badly damaged parapets, it may sometimes be necessary to reconstruct the masonry upstand. The demolition or taking down of the parapet is likely to require planning permission. The existing parapet should be recorded and the new parapet detailed to match, providing that the earlier detail was not the cause of the damage.

Sometimes decorative Roman cement was used to embellish the front face of parapets. These features or cornices are prone to decay where water can lodge on the damaged or porous upper ledge of the projecting plasterwork. Such work can be repaired or replaced using an appropriate plaster, and a template can be made using the original surviving detail. Local repairs can be carried out where the overall integrity of the cornice has not been lost, and a lead dressing or hood can be applied to protect the upper profiles of the consolidated plaster work. Some plaster cornices can be run in situ. These types of repair should be carried out by a specialist conservator. They should be factored in as part of an overall roof project, to take place when scaffolding is already in place in order to minimise the associated costs. The replacement of plasterwork features with modern fibreglass products is not appropriate; such products are unlikely to withstand the exposure of the location over a long period.

Decorative stone, plastered brick, Roman cement or cast-iron balustrades, urns or other architectural

features were frequently fixed to parapet walls. They should be inspected regularly to ensure they remain securely fixed. Depending on the material of their construction, the levels of exposure and the amount of maintenance they have received over time, these features can become eroded or decayed and may require specialist advice to be correctly repaired. It may be necessary to consult a stone, plaster or ironwork conservator for detailed advice.

VALLEY AND PARAPET GUTTERS

Valley and parapet gutter problems are generally caused by inadequate maintenance (lack of safe and easy access to the roof is frequently a contributing factor) leading to a build-up of debris, silt and vegetation. Water can build up to such a level that it overflows the top of the lead gutter lining. Unseen valley gutters on double 'A' roofs with secret gutters channelled through the roof space cause considerable damage if they become blocked. Blockages of debris or outlets of restricted size in the central valley may be the cause of the problem, as the water draining from the roof slopes cannot flow away quickly enough. The pressure of a surge of water on poor or badly formed outlet pipes can press on the outlet pipe, allowing water to leak at the junction of the pipe and gutter.

Often the parapet gutters and central valleys are too long, constructed with an inadequate fall and/or using inappropriate lead sheet sizes. The timber boards supporting the lead may subside, resulting in water falling back into the valley and causing continuous pooling, which eventually leads to an exacerbated depressed section of gutter. Where previous repairs in parapet gutters and central valleys were executed using poor quality or inferior roofing materials and details, such as torch-on felt or silicone products, it is only a matter of time until water eventually starts to lodge and to leak down into the valley boards and roof structure below.

The materials used in repair should be suitable for the purpose. They should not deteriorate in ultra-violet light, or expand and contract at a different rate to the valley materials to which they are attached. Lead and copper are the traditional materials used to form valley and parapet gutters. However, defects can arise in the performance of these materials if they are not correctly installed. There are established guidelines for the maximum width and weight of lead and copper in specific situations and these should be adhered to. Defects may also arise from the impact of people walking and working at roof level, by the imprint of



View of a defective valley gutter with a shallow fall that is now holding water. Birds' nests in the outfall of the secret gutter (seen at the top of the image) blocked this roof outlet

boots or by dropping sharp objects which could be pressed into the lead or copper.

Care needs to be taken in the setting-out of long, lead-lined valleys. The gutter material should be dressed under the slating to a consistent height, even where numerous steps in the leadwork are required along the length of the valley. If it is not feasible to redesign the valley for improved falls, then the replacement of the central valley covering with copper may be an alternative, as copper does not need to be stepped and can be installed to lower falls. This will not be an option if there are adjoining roofs served by a continuous valley, unless all owners agree to a common solution.

Condensation created within the attic space of a structure may form on the underside of lead or copper valleys and in areas of restricted ventilation near the top of structural walls. For this reason, it is important to ensure that new metal valley and parapet gutters are properly constructed, using an isolating membrane between the valley timbers and the copper or lead sheeting and ensuring there is adequate ventilation.

Utility cables running along parapet and valley gutters, perhaps even the full length of a terrace, are a potential problem as they can cause ponding of water and build-up of debris.

SNOW BOARDS AND ACCESS BOARDS

Snow or access boards are sometimes found in hidden gutters. These running boards are laid in both valley and parapet gutters and are like gangways or duckboards on a boat. They are typically constructed of good quality softwood as hardwood tends to be slippery when wet. Modern materials may provide alternative, longer-lasting solutions depending on the situation. The primary function of snow and access boards is to allow blown debris to remain on top of the boards whilst not impeding the water flowing underneath, but they also afford a level of protection to the roof covering, preventing puncturing from pedestrian traffic.

After heavy falls of snow, when the depth of snow is likely to exceed the height of the sides of the gutter linings, snow boards allow the melt water to flow away freely beneath the accumulated snow. In most areas of Ireland, a properly detailed tapered valley or parapet gutter will rarely experience problematic snow and meltwater levels. However, where snow conditions are known to be severe, access is difficult or the building fabric or contents are particularly valuable, proprietary electric heating tapes laid in the gutters, catch pits and hopper heads can be considered as an alternative, or an addition, to snow boards.

Snow and access boards need to be maintained as they can frequently trap debris, and if allowed to deteriorate can end up blocking the gutters and rainwater outlets they were meant to protect. It should be noted that they can constitute a significant trip or fall hazard at roof level, particularly when they are in poor condition.

RIDGES AND HIPS

A missing ridge cap allows the penetration of water into the roof at a very vulnerable point. Replacements are generally available for historic clay ridge tiles, though care should be taken, as the angle of each ridge cap may vary and the colour or glazing may differ. Where there are no equivalent modern versions in production, some companies may be able to match unusual profiles. Clay ridge tiles should be bedded in lime mortar and a consistent ridge line formed by tight, well pointed-up joints. The ridge and hip tiles should not be fitted with wide joints in order to avoid making up a shortfall of salvaged tiles. This is a false economy as it results in fat, highly visible and more vulnerable mortar joints.



Incorrect bedding and detailing, with fat joints to the ridge and hip tiles, are visually very disruptive and inappropriate to a historic building

On hipped roofs, to reduce the impact of the weight of the clay hip tiles and to prevent them slipping down the roof, a decorative wrought-iron strap known as a hip iron was sometimes fixed to the top of the hip rafter to support the lowest tile. Less decorative straps were concealed in the bedding for the ridge stone or hip tile at eaves level. Where the irons have corroded, the hip ridge tiles can start to move, creating gaps and allowing water penetration. This movement eventually results in the hip tile falling off the roof. Pig tail hip irons (so called because of their decorative shape) are commonly available but should not be used for repairs unless there is a historic precedent for the design. A plain, buried fixing should be used instead. In most cases, provided the hip and ridge tiles have not been previously fixed with concrete, it should be possible to remove the tiles without damage to the underlying slate. The hip irons can be fixed directly to the rafter provided that the underlying timber is in sound condition. Where a lead ridge or hip roll has slipped or torn, the replacement should follow the detail illustrated here.

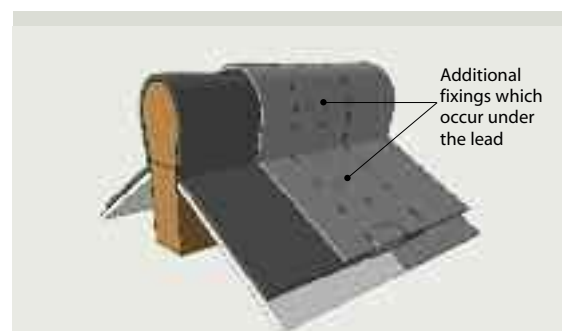

The Lead Sheet Association advises a modification to the profile of the 'broom handle' timber roll and promotes instead the use of a more elongated section in treated softwood to reduce the likelihood of the pinched lead cracking along the roll



Interleaved soakers: a variation of the external lead roll is the cloaked version seen on hips of roofs, which conceals much of the leadwork below the slate courses. In this detail, the lead flaps are interleaved with the slate on the ridge or hip. If this detail requires repair or replacement, local re-slating of the roof will be necessary to access and replace the damaged leadwork

GABLES, VERGES, COPINGS AND ABUTMENTS

The slate covering at a flush gable was traditionally fitted tightly on top of the wall by bedding the outer slates in a lime mortar. As this detail is vulnerable to severe weather, the use of lime mortar for repairs is of particular importance to ensure that there is sufficient tolerance for the slates to move. To preserve historic details and character, the salvage of large slate sizes to achieve the 'slate and a half slate' detail at the gable verges is an important aspect of any re-roofing process. By virtue of their size and weight, these large slates, bedded in lime and held by the adjoining slates, tend to outperform details comprising smaller slates. Where 'slate and a half' sizes are not available and a half slate is used at the gable verge, it should be fixed twice to prevent wind lift at the edges. It is good practice, when laying slate to a closed verge, to ensure that there is a slight fall back in the last slate towards the roof to direct the water away from the edge of the verge. This can be formed by packing out the lime bedding below.

Note that this does not apply to the installation of the undercloak slate. The slate overhang at the verge should not be over-long as, in an exposed location, wind can lift the last row of slates. Wind uplift wears the nail hole fixings, eventually resulting in slate slippage.

In many areas, particularly those noted for high winds, a stone gable coping was used, set in mortar and on top of the roofing material. A more modern version of this detail is a lime- or cement-based gable coping, cast in situ.



A gable detail where the verge is held or 'locked' in place with a stone coping. A particular difficulty arises with this detail if there is damage to slates set below the coping, as the coping will need to be removed to allow for repair of the roof covering

When a gable coping is set directly onto a corrugated iron roof, problems may arise with corrosion of the corrugated sheet in contact with the lime or cement products. A protective layer of priming paint can reduce the likelihood of corrosion where the sheet is in contact with these products.

Where a gable or party wall is raised over the roof slope it is known as a roof abutment or a gable parapet. These parapet walls, having exposed faces on both sides, are vulnerable to extremes of weather, and the masonry can become susceptible to water ingress

over time as the render or covering material deteriorates. Lead soaker flashings dressed into the masonry projection can tear or lift due to the use of an incorrect weight or length of lead. Unless party wall abutments are historically a feature of the original roof design, it is better to avoid introducing them, due to problems of weathering this detail effectively.

Overhanging verges are generally constructed of timber, with a timber or plaster soffit to the underside of the over-sailing rafters and gable purlins, and in some cases a decorative timber bargeboard. If not maintained and painted regularly the timber can deteriorate rapidly. It is important, when scarfing or jointing-in replacement sections to damaged lengths of bargeboard (as with a decorated fascia), to ensure that the grain is similar and correctly orientated to the original timber for the most effective repair. Where entire sections are to be replicated, it is important that the quality, section size and profile of the timber are correct. The patterns for decorative bargeboards are normally repeating, so sections can be made to match a known template.



The poor condition of overhanging verges can lead to deterioration of the ends of the purlins as well as the loss of sections of decorative timber bargeboards

EAVES

Defects may be caused by slipped or missing gutters, causing water damage to the eaves fascia and soffit or rafter ends. It is important to repair accurately a detailed decorative eaves fascia, or replicate lengths where necessary, by using correct timber profiles or sections.

FLASHINGS

An abutment flashing is fitted to weather the junction between a roof and a wall, for instance at a chimney or parapet. Where a new or replacement lead flashing is to be fitted, it should be turned into the joint by at least 25mm, but generally not more than 50mm. Abutment flashings are usually fixed into the joints using lead wedges and then the joint is repointed. The wedges are simply strips of lead sheet folded several times to suit the thickness of the joint.

Flashings slip, lift or tear under constant exposure to weather. Wind rapidly undermines loose flashings and quickly dislodges them. Any failure of a flashing on a roof should be addressed as a matter of priority due to the likelihood of water ingress and damage. In the short term, the use of a temporary patch repair to prevent water ingress and to safeguard against damage to the ends of major structural timbers in the roof should be considered a top priority. Historic roof timbers, once softened by water, can be prone to insect infestation or the reactivation of timber rots. Damage may also be caused to internal fabric and finishes.

FINIALS AND DECORATIVE METALWORK

Decorative embellishments of stone, fired clay or ironwork on roofs should be regularly inspected to make sure they are securely attached and are not cracking or corroding. Finials may also function as lightning conductors or as vents. Repairs will sometimes require that the feature be removed from the roof and brought to a workshop. A ceramic or stone conservator or specialist metal worker should be consulted in the case of the respective type of embellishment. Repairs will have to withstand the severe weather conditions of their original location.



This terracotta ball finial was cracked; as part of a roof repair project it was removed, carefully cleaned and repaired before re-installment

Rainwater goods

Defective rainwater goods can be responsible for large amounts of water penetrating into historic fabric. Regular inspection and cleaning of the rainwater disposal systems of a building are essential maintenance tasks.

The life expectancy of lead is in excess of 200 years, and as the material will not rust painting is not necessary. Where the existing rainwater disposal system is made of lead, there is often a temptation to use less expensive substitutes for repair or replacement. Appropriate high-quality alternative materials to the correct profiles may be justified in some circumstances. If there is a high risk of theft, for example where the lead is easily accessible or in a remote building, steps should be taken to reduce its vulnerability.

The most commonly used material for rainwater goods on historic buildings is cast iron. Cast-iron rainwater systems are far superior to many modern alternative materials. However, iron is prone to corrosion if not maintained effectively. Cast-iron goods should be retained, maintained and repaired where possible, as the weight and durability of the original material is better than extruded metal or plastic systems. Where pieces of guttering or downpipes are missing or beyond repair, replacement cast-iron



A new flush eaves gutter formed in lead along the top of the wall

sections matching most profiles are readily available. Most substitute materials look different, perform badly at exposed heights and rapidly twist or slip off the line of the eaves causing rainwater to overspill. For advice on the repair of cast iron, see *Iron – the repair of wrought and cast ironwork* in this Advice Series.

GUTTERS

The condition of eaves gutters can often be superficially assessed from the ground. However, a more detailed assessment should be made on a regular basis from a ladder or scaffold, to check that there are no underlying issues such as cracking to the back of the gutters next to the masonry, and to assess the condition of the brackets and the joints between sections of guttering. The base of the gutters should be checked for soundness, as weak organic acids and salts in a build-up of bird droppings or other corrosive pollutants can attack the metal. The fall of the gutter should be checked to ensure that it directs rainwater down towards the downpipes. The fall can change with time due to distortion in the roof framing or damage to gutter brackets from the weight of debris and water. Damage from ladders, wind pressure or from falling branches off nearby trees can also contribute to the deterioration of rainwater goods. Water sitting in the gutter or a build-up of debris can weaken the gutter supports, leading to breakage in the gutter and water penetration into the roof or wall. Ideally, the outer edge of the gutter should be lower than the inner edge, so water spills away from the wall of the building if blockages occur.



Cracked or broken rainwater goods can be replaced on a like-for-like basis with half round, box or ogee cast-iron gutter profiles which are readily available. Where castings are more decorative, such as in this case, new gutters can be cast to replace the broken sections. Downpipes should be carefully examined, cleaned down and fully refurbished on a regular basis

Overflow pipes can be fitted to hopper heads and catch pits to alert owners of blockages. Where the gutters are hidden from view, such as secret or valley gutters, this is an especially useful early warning system and should be included when any major roof repair works are undertaken.



An unusual example of a decorative cast-iron gutter detail following the profile of a half-hipped roof

DOWNPIPES

Downpipes should be examined for defects, cleaned down and appropriately refurbished. Replacement sections for broken lengths of downpipe should match the existing size and profile. Where downpipes have been partly buried into walls by a coating of render they are liable to crack, discharging rainwater back into the interior of the structure. Spacers should be fitted to ensure that downpipes are properly held off the wall, so that if leaks occur the water has sufficient space to run down the back of the pipe without saturating the wall. Where appropriate, fitting hinged downpipe brackets is very practical as it simplifies the removal of downpipe for maintenance or replacement.

If there are deficiencies in the design of a rainwater disposal system it may, in some cases, be possible to replace the existing rainwater goods with larger sections in similar designs and profile. This may not be appropriate where the existing rainwater goods are of architectural heritage value. Sometimes it may be possible to increase the number of downpipes serving a roof or to add a new downpipe to a previously unserved roof area. Depending on the location of the additional outlet and downpipe, planning permission may be necessary for the modification and/or consent from adjoining property owners obtained.

Some gutters, particularly those with a decorative profile, cannot be taken down for repair without removing the lowest course of roof slate. Where such gutters are cracked or have spots of corrosion, a metal insert or continuous sleeve can be fitted into the gutter, to cover the faults. The chosen metal should not cause galvanic corrosion. It should be fitted in dry conditions to avoid water being trapped between the two surfaces. This repair should suffice until a major roofing job is undertaken and a permanent repair can be achieved. For further information see *Iron – the repair of wrought and cast ironwork* in this Advice Series.

Having made sure that the method of rainwater disposal from the roof is in working order, it is important to ensure that downpipes are properly able to discharge into shores or gullies at the base of the building. The base of the downpipe should not obstruct the grating or impede clearing of the gully.

SECRET GUTTERS

Secret gutters are concealed channels which run through a roof space to drain into a parapet gutter or a central well, such as where four internal roof slopes converge to an enclosed area. A secret gutter relies heavily on the fall of the lead-lined box gutter receiver to work effectively. Because of the inaccessibility of a secret gutter, it is prone to unnoticed blockages. A grating to prevent bird ingress and blockage from leaves or debris should be installed and regular maintenance inspections carried out to ensure the gutter remains free-flowing. The alternative detail of piping the secret gutter through the roof should be considered if carrying out major roof repairs as it makes this detail significantly less vulnerable to leaks within the roof space.

Occasionally in terraced buildings, a secret gutter is shared by two adjoining properties and is typically carried along the top of the party wall within the attic space. The party walls in terraced houses were often not built up fully to finish beneath the roof slope. Therefore many terraced houses are not fully separated or independent in terms of a structural fire break at roof level. In re-roofing a structure, the completion of the party wall to achieve a fire break at roof level should be considered. Where this is desired the internal gutter should be re-routed as two separate gutters either side of the extended party wall to a detail agreed by both building owners.

The term 'secret gutter' is also used to describe a partially concealed gutter to the base of an abutment or gable coping. Where the roof is being re-slatted its profile will most likely be increased in height by the addition of new battens, which are thicker than were formerly used, or counter battens (an additional layer of battens fixed perpendicular to the first layer of battens). The relationship between roof covering and coping upstand may therefore be altered. If there is a risk of water penetration below the lead flashing, a recessed or secret gutter can be formed if the roof is counter-battened, and an appropriate lead upstand formed to the coping. These works may materially affect the character of the roof, and the architectural conservation officer in the local authority should be consulted regarding the necessity of obtaining planning permission.



A lead-lined, secret gutter within the roof space used to carry rainwater from an internal roof to outfall at the eaves



The installation of an early warning system in the form of an overflow pipe will alert the owner that the catchment pit is full and that a blockage in the gutter or hopper head needs to be cleared before excessive damage occurs



This so-called 'secret gutter' detail is not a traditional one. However, it may be recommended in instances where there is a history of water penetration below lead cover flashings at the junction with abutments, particularly on roofs of a low pitch (Note: in this image the gable capping stones have yet to be replaced)

Slate repair

LOCALISED SLATE REPAIRS

Once a slate has been lost from a roof slope, rapid deterioration from water penetration and wind suction on the exposed fixing of the adjoining slates will occur, as each slate is dependent on the overall integrity of the roof. Slipped slates can be readily re-fixed by the use of 'tingles' or hooks, often in the form of lead clips or powder-coated stainless steel hooks, which allow the lost slate to be re-positioned within the body of the roof cladding. There are also proprietary fittings or secret fixings available for re-fixing slipped slates. These are readily inserted into a roof covering and are not visible on the external roof slope.



In some cases, the use of a cherry-picker may be an economical alternative to scaffolding for undertaking maintenance inspections and minor repair works to high roofs

Owners or custodians of properties roofed with native Irish slate, in particular, may encounter difficulties in obtaining a ready supply of replacement slate. Therefore it makes sense to carry out regular preventive maintenance inspections and localised slate refixing to minimise the risk of damage. If the slates are of Irish origin and are rare, it is unlikely that a matching slate type or size of slate can be obtained, even for a small local repair. A reputable source of salvaged slate may be an option in some cases. Alternatively, an imported replacement slate with similar characteristics may be sourced for the repair. The retention in situ of as many of the original slates as possible should be a priority of the roofing project.

When dealing with the replacement of a single slate or a small number of slates, it is important to determine the size and provenance of the original slate in order to match its colour, texture and thickness. The thickness of the slate is important if it is to be bedded correctly to the surrounding slate. If a slate which is too thick is inserted in a local repair there will be a noticeable 'kick' in the roof, as the slates either side will not lie flat. Traditionally the edge of the slate was dressed so that it bevelled back to the plane of the roof and should be redressed if the slate is cut or turned over.

Repair methods for top-hung slates



Earlier slate roofs using top-hung, single-nailed slates can easily be repaired by swinging individual slates aside allowing access to replace or re-peg the slates beneath



Slates are swung back into place after works



An alternative repair method is to tie the slates within the roof. This is useful where the slates are large or have square shoulders or, for some other reason, cannot be swung aside. A plastic-coated wire such as electrical lighting wire is threaded through the gap from inside the roof and attached to the slate outside. The slate is then carefully pulled back into position and the wire tied back to the timber roof structure

REPAIRING OR REPLACING BATTENS

Modern batten sizes tend to be larger than the sizes historically used. Irish standards for batten sizes take account of rafter spacing, which has increased from a typical historical spacing range of 300mm to 360mm (12 to 14 inches) apart to one of 400mm to 600mm on trussed rafter roofs. The thicker batten not only spans the increased spacing, but allows the use of a longer and more secure nail for fixing the slates without puncturing the roof membrane beneath. Also, during works the thicker batten provides a more secure foothold for the roof worker.

On a historic roof the use of thicker battens, and possibly also counter-battening in tandem with the use of breathable roofing membranes, as part of a re-roofing project may change the height of the roof plane, causing a difficulty at junctions with adjoining terrace roofs or roof parapets, and as a consequence may force a change to the original roof details. The height difference between the old and the new roof coverings may require the insertion of a lead soaker or upstand along the party wall line. This soaker detail has merit in facilitating the difference in height and providing a clean edge or datum to which the new roof covering may be finished out. However, in a terrace of structures with original roof coverings still intact, this detail may be visually disruptive from the street. Consideration may be given to using higher grade timber, as the greater specification may allow the cutting of the battens to a size closer to the historical dimension and eliminate the requirement for a soaker flashing.

New battens should be pre-treated and fixed to the roof rafters with ringed stainless steel nails. Copper nails with medium diameter shanks and large heads should be used for the fixing of slate. The use of stainless steel nails or silicone bronze for fixing of slate is not recommended except in areas of severe exposure, as they are more expensive and problematic to remove in the case of future repairs. Sometimes the use of nails for fixing is not appropriate because of the potential damage to significant plaster and lath ceilings immediately below. In these instances, screws of a non-corrosive material such as brass are recommended.



A lead divider batten roll can be used to disguise a difference in level caused by the use of deeper battens. The use of larger battens when re-roofing or the use of counter-battening with roof membranes can mean an increase in the roof plane height. This causes a difference in height between roofs in a terrace of buildings and a lead soaker may be used to accommodate the difference in levels



Slates properly stripped and sorted

FULL RE-SLATING

Ideally, slipped slates and failed fixings should be repaired locally with minimal disruption of the historic fabric. However, if failure is widespread, a decision may need to be taken on whether or not the roof needs to be fully stripped and re-covered. As a rule of thumb, if an area of between 25 per cent and 30 per cent of the slates have slipped, cracked or are broken, or where there is evidence of widespread failure of the fixings, it may be a more practical solution to strip the existing roof covering and re-slate the roof, rather than repair only the defective slates. An assessment should be made as to how much of the original material can be salvaged for reuse, taking into account the requirement for integrity and durability in the proposed roof covering. Stripping and re-cladding the roof of a protected structure or a building in an architectural conservation area may require planning permission, and the advice of the architectural conservation officer in the local authority should be sought when any works are being considered.

When the wholesale replacement of a historic roof cladding becomes necessary, it should be carried out using materials that match the original as closely as possible in terms of quality, appearance and performance. Logically this would suggest the same quarry for slate as originally used. However, this is not often achievable for practical reasons such as costs, availability of material and sometimes also the need to correct some design flaws in the historic roof. A decision may be made as to which is the most important roof characteristic to be maintained, if the salvaged slate previously turned cannot be reused. The issues for consideration concern the size, colour or texture of the proposed slate in relation to the original slate. The context of the building (whether within a terrace or a freestanding structure) and the rarity of the existing roofing material will also have a bearing on the development of an appropriate conservation strategy for the roof works.

A major factor for owners and custodians is the cost associated with providing the full replacement covering, versus the accumulation of incremental costs for ongoing piecemeal repairs, insurance, scaffolding and the like. There will come a day when the decision to re-roof will have to be made. Compromise is often part of the final decision reached. The cost of replacement slate and scaffolding is a sizeable investment, which can be underestimated. A well-

detailed new or re-covered roof should be fit for purpose for the next 40–80 years, and commonly longer with regular maintenance and occasional local repairs, depending on the slate used in the re-covering and the quality of the work. Approximately 75 per cent of the original slate should be salvageable if the slates have not previously been turned and are generally in a sound condition. If a shared roofing project can be undertaken with an adjoining property the costs of scaffolding can be reduced, which makes good economic sense as well as having practical benefits such as ensuring a seamless repair to the roof covering. If extensive repair work is envisaged, the propping of plaster ceilings below is essential, and the design of a temporary roof covering and temporary rainwater chutes should be factored in to the project.

STRIPPING SLATES

During the stripping and sorting of slate from a roof, a loss of 25 per cent of the slates can be anticipated. However, with careful handling, loss of original slate can be minimised. The salvaged slate should be carefully sorted according to slate type, size and thickness and left accessible for reuse. Slates are best stored on edge in batches of twenty separated by a timber batten to facilitate ease of installation. Sometimes the storage of slate at roof level is advisable, and avoids repeated handling of the slates; however, the potential loading on the scaffold needs to be carefully considered. Clay ridge tiles should also be carefully salvaged and set aside for reuse where possible. If the original roof was laid with diminishing slate sizes or patterns in the slates, this should be noted and recreated. A good roofer will only strip the amount of roof covering that can be protected as work progresses.

REUSING SALVAGED SLATE

Salvaged slate can be used on the most prominent slopes, or cut down and re-dressed to be used on lower roofs requiring smaller amounts or smaller slates, such as porches or bays, where the scale of the slate is in proportion to the size of the roof.

Generally, the rule of thumb to achieve a good visual proportion is that the smaller the roof, the smaller the slate. Where a shortfall occurs in the salvaged slate, newly quarried slate can be used to complete a less prominent section of the roof, for example, on inward-facing slopes or, where there is a parapet wall, on the bottom courses which are not so visible from ground level. However, modern slates tend not to correspond to the original historical sizes, and a check should be made to ensure that the size supplied corresponds with the historical sizes. Where large slates (up to 20 x 36 inches, the former King size) are salvaged, they should be considered a premium slate due to their size and quality. This size of slate is no longer manufactured, and slates of this type should not be carted away. It is of great importance that any sound large slates are retained and not cut down as they are invaluable as undercloaks, or for re-forming the eaves detail to make up a shortfall. A damaged large slate may be re-cut with a slate cutter to obtain smaller useable sizes. The edges will also need to be re-dressed.

If slates have been previously turned or salvaged they will most likely have reached the end of their useful life. Slates can be reused twice, however three times makes them too brittle. A sound slate or a high grade slate, when poised on the finger tips and tapped with a hammer, will emit a clear sound. A weathered or damaged slate is much less sonorous and gives off a dull thud when struck in a similar fashion. Care should be taken if the slate has been previously holed. Where slates were double-nailed at the midway point and at the head, the hole positions may render them unsuitable for reuse as undercloaks (that is, as the larger slates laid first and face-bedded at eaves and verges).

All debris attached to the underside of the previously used slate needs to be removed with a stiff wire brush and hose so the slate can sit properly when re-laid.

ISSUES CONCERNING SALVAGED SLATE

Slate taken from standing buildings should not be used, as it creates a market for the dismantling of historic structures instead of promoting their repair and reuse. This is particularly important where slate is concerned, as the removal of a working roof will lead to the rapid deterioration of a building. However, many types of slate are no longer manufactured in Ireland and the use of second-hand slate may be an option for making up a shortfall in a re-roofing project. Owners should satisfy themselves that the salvaged slates they intend to buy were not taken from an otherwise usable building and that they have not previously been recycled.

SOURCING REPLACEMENT SLATES

When replacing the full roof cover, consideration should be given to how much of the original material can be salvaged for reuse. This decision should be carefully matched against the requirement for integrity and durability in the proposed roof covering. Where the salvaged slate is reused on the more prominent parts of the building, it is desirable to match the colour or texture of the salvaged slate with a newly sourced slate for the rest of the roof.

In single slate replacement, second-hand slate may need to be sourced by specialist companies to ensure a correct colour size or thickness grade. There are many alternative roofing products available, such as slate originating from Spain, Brazil, Canada and the like, which are reported as compatible and appropriate alternatives to traditional sources of natural slate in Ireland. However, they may not possess similar characteristics, such as finish, especially when they are wet, nor match the performance standards of the historic slate originally used. Alternative natural slate products, whilst they overcome many of the negatives associated with artificial products, may perform differently in the Irish climate, where their longevity has not been adequately tested. Where cost is the primary focus of the conservation debate, these new imports may sometimes provide the only option for re-roofing with a natural slate.

When choosing a specific slate, its characteristics should be assessed against European standards (the EN rating). This information may not be available for slates sourced outside Europe. Sometimes the data available is based on non-standard tests, so comparisons may be difficult. EN standards were formulated in the attempt to apply uniform testing to standardise characteristics of the many different natural slates and stone used in very different climatic conditions throughout Europe. This does not benchmark the qualities of a good slate or stone but instead ensures that the information provided by each supplier/quarry is standardised. It is now up to the specifier of slate to ensure that these characteristics will be suitable for the climate or environment in which it has to perform. The standard also requires that there is traceability of the slate; every crate is required to be labelled, and characteristics given by reference to the standard on an accompanying document.

While newly quarried Welsh slate is the most common natural slate specified for the repair and re-covering of historic roofs in Ireland, there are considerable differences in colour, quality, thickness and size between the modern slate and the slate worked in past centuries from the same quarries. Until recently in the construction industry the tendency was to specify Bangor Blue slate as being synonymous with a natural slate, and very little thought was given to its grading or performance because of its tried and tested use in Irish conditions.

Modern Welsh slate is available mainly in metric measurements to a standard size of 500 x 300mm. Special orders of smaller sizes can be sourced, such as 16 x 8 inches (400 x 200mm approximately) or 14 x 7 inches (350 x 180mm approximately). Where modern metric-sized slate is being patched into a historic roof of imperial-sized slate it may be difficult to match the old and new successfully. A possibility is to reuse the existing slates on the most important elevations and the newer slate to less visible areas such as valleys or to a less important roof in a complex, where the different size will not be noticeable.



The mix of roofing materials on this terrace of houses visually fragments its appearance. The use of 'artificial slate', or fibre-cement tile is visible in the foreground, and also further down the street, striking discordant notes among the original slate-covered roofs

Roofs possessing very large slates (typically slates over 24 inches, or 600mm, in size) should be re-slatted using the same slate by ensuring careful stripping of the original roof for reuse, with the addition of some shorter courses further up the roof to make up the shortfall. The colour and pattern of the slates, if decorative, should be replicated.

Original slate	Colour	Availability of reclaimed slate	Closest match in new slate
Irish slate			
Ahenny, Co. Kilkenny/ Co. Tipperary	Blue/grey	Limited amounts available	Blue/black Spanish Valdocal R5 Intradima R83
Benduff, Co. Cork	Grey/black	Few survive in reusable condition	Cupa Quarry H5 Cupa H83 Villar Del Rey
Convoy, Co. Donegal	Grey/black	Limited amounts of smaller sizes available	Blue/grey Spanish Piforsa R3
Glaslacken, Co. Wexford	Grey/green	Limited amounts available	USA Weathering Green in small randoms
Killaloe/Broadford, Co. Clare – Portroe, Co. Tipperary	Grey/green	Available both random and sized	USA Vermont Green Brazilian grey/green
Valentia, Co. Kerry	Dark heather	Limited amounts available	Valentia quarry is still open although only producing flags, slates in small sizes can be produced
Welsh slate			
Penrhyn (Blue Bangor)	Heather	Available both random and sized	Penrhyn Quarry, Bethesda
Caernarfon	Plum red	Limited amounts available	Canadian Heather, Newfoundland
Dinorwic	Dark heather	Limited amounts available	USA Bangors Penrhyn Welsh Hard Greys
Porthmadog	Blue/black	Some available, mostly sized	Vilarchao Campo Rande PR Ferlosa PR
English slate			
Delabole	Light grey	Limited amounts available	Campo Rande Spanish Inlusa
Westmorland	Olive green	Limited amounts available	Cumbria Quarries: Burlington, Kirkstone, etc.
Scottish slate			
Ballachulish	Silver/grey	None available in Ireland	Piforsa Heavy 3
Other slate			
American Bangor	Dark heather	Rare	USA Bangors (Evergreen Slate Company)
Norwegian quartz	Silver green	Few available	Available new in small quantities

Table of possible suitable sources for matching existing slates. Alternatives are given by quarry. The quarries receive the EN certification (a European standard), which is reviewed on a yearly basis. As a general rule, any supply of slate which arrives in unlabelled crates should be queried

RE-SLATING: SORTING THE SLATES

Historically, slaters were responsible for sorting or grading natural slates on the ground into three or four different thicknesses, prior to fixing on the roof. The thickest grade and best quality slate was used for courses at the eaves of the roof, the level which receives the most water, progressing up the roof towards the thinnest grade at the ridge. Where the roof was a gauged roof, the slate would be additionally sorted by length, the largest sizes for the eaves reducing towards the ridge, and also graded within each grouping for thickness. This grading allowed slates of a similar thickness to be laid on adjoining courses, preventing unsightly kicking up or gaps, which could lead eventually to slate loss.

Slate produced using modern quarrying processes now arrives on site in crates, in most cases pre-holed and pre-graded according to the quarry's designation. Grading is generally by thickness, but may also take account of colour, or of purity in terms of markings or texture. The grading process in the factory may have been perfunctory and the slater should generally not use slates directly from the crates without some further sorting on site. The grading of slate prior to fixing is of particular importance on roofs of a slope less than 30 degrees, as any slate which has a thicker tail or end (the visible part of the slate) will be very noticeable on the external roof slope. The omission of site sorting prior to roofing will often result in a poor appearance of the finished roof.

HOLING OR RE-HOLING A SLATE

If holing is required then it should be from the bed side through the thinnest part of the slate, leaving the thickest part of the slate towards the tail (the exposed area of slate on a roof). Slates were traditionally punched through with a slater's axe or machined punched to form a countersunk depression on the face of the slate. A large number of new slates, approximately 20 per cent, are now drilled at the time of manufacture rather than punched from the bed side. The countersinking detail was important so that forged iron nails lay flat, but modern copper nails have a flat head so this does not present an issue.

GAUGED SLATE ROOFS

Slates are priced according to the amount of labour associated with their production, the most expensive being the thinnest and in the largest sizes. Gauged roofs require a schedule for battening to be set out for the roofing contractor to follow. Diminishing courses may be in 2, 3 or 4 inch increments (50mm, 75mm or 100mm respectively). Graduated or diminishing slate courses cannot be laid where the slate is supplied with pre-drilled nail holes.



An example of a gauged roof of Ahenny slate, where the sizes of the slate courses gradually get smaller, or diminish, towards the ridge of the roof



Large eaves slates helped to ensure that a good weatherproof detail was achieved where the accumulation of rainwater was greatest. It is a particular feature of historic slate roofs and should be retained when undertaking repair works

Achieving a steady incremental decrease in course size in a gauged roof relies on the skill of the slater to be able to determine the weight and headlap, which varies with each course as work progresses up the roof slope. In the covering of roofs with varying degrees of headlap, a minimum headlap should be maintained, i.e. 4 inches (100mm) in most cases, or even up to 5 or 6 inches (125–150mm) in lower-pitched roofs in areas of more severe weather conditions.

EAVES SLATING AND UNDERCLOAKS

The characteristic large slate course at eaves level should always be carefully salvaged for reuse as the loss of this detail by re-slating the roof in one regular-sized slate dilutes the historic character of the roof. While the industry recognises this gap in the market and can provide replacement large eaves slates, these are not routinely imported into Ireland at present. Therefore an owner may be dependent on salvaged slate to complete any shortfall.

Damaged large recycled slates can be cut down and redressed for use as undercloaks. The practice of using man-made fibre-cement tiles as an undercloak should never be followed, as artificial products are visually different and age more quickly. They become fibrous over time, leading to water retention and eventually water penetration to the top of the wall. In addition, the colour of the fibre-cement washes out over time, giving a pale line at eaves level.

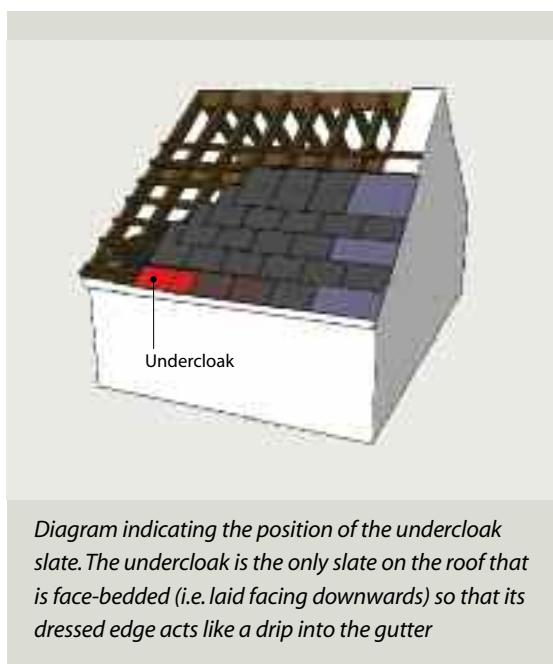

PARGING, SARKING AND FELT

The repair of parging may be impractical due to restricted attic space. However, local repairs should be attempted if the roof parging is generally intact. If the parging has become detached and fallen, it should be removed from between the ceiling joists, as it may cause detrimental loading to the ceilings below.

Sarking was the cladding of the roof rafters with deal boards on which battens and counter battens were then fixed. It may require attention if moisture has



Substantially intact parging to the underside of slates is visible from within the attic space and provides a secondary line of defence against rain and wind entering the interior of the building

penetrated the roof. Historically, sarking was composed of high-quality deal; hence, joinery techniques of timber repair can be used where board ends have decayed. However, where there is widespread saturation and damage, sarking should be replaced. White deal is usually specified for internal work; however where there is a possibility of rain penetrating the cladding, a higher quality deal should be specified in preference and appropriately treated after cutting and prior to fitting.

From the 1950s onwards, the use of roofing felt as an additional barrier below the slate covering was a further development of sarking boards or lime parging. The use of felt may give rise to a build-up of moisture levels and the possibility of condensation forming within a roof space, unless adequate ventilation is provided. Unlike breathable membranes, the use of felt adversely affects the ability of a timber roof to regulate and release moisture build-up. Roof timbers may eventually become vulnerable to timber rot if left in warm, moist, poorly ventilated conditions.

REPAIR OF VERTICALLY HUNG SLATING

Generally, taking out only the damaged slate is a successful method of repairing individual slipped, vertically hung slates. However, if the mortar has been directly applied onto a rubble stone wall, obtaining a new bed for the replacement slate without loosening the surrounding slates is difficult, particularly where there is a large headlap. It is important to remove the remains of the lime bed of the slipped or broken slate so that the replacement slate can be fitted tight to the

adjoining slates, as vertically hung slating is typically found in areas subject to high levels of wind suction. The careful use of a slate ripper may be appropriate, allowing a new slate to be slipped under the still-intact slate. A proprietary stainless-steel fixing clip or hanger, to take a new slate, may be installed into the joint between the headlap of the lower slates. A lime mortar can be buttered onto the back of the slate and the slate pressed back into position at the head and clipped at the tail. Any extraneous lime mortar should be removed so it is not visible at the edges or on the faces of adjoining slates.



On this ruinous house in County Cork, the vertically hung slates, bedded in lime mortar, were later rendered over. Their existence only came to light as the external render decayed and fell off

If a large area of vertically hung slating becomes defective, then all the rows of defective slate should be removed back to the lime bedding, so that the slate and the lime bedding can be repaired in unison. The traditional method of application should be used to apply the replacement slates. The mortar mix for reinstatement needs to be a very rich mix of 2:1 (sand:lime) or 2½:1 (sand:lime using a naturally hydraulic lime, NHL 3.5 or NHL 2), or a pure lime putty. This is a sticky mix and helps in the initial adherence of the slate. As the mortar is fully protected by the slate, the very high lime content and potentially low strength of the mortar is not an issue.

Vertically hung slating should not be repaired with mastic spread over the back of the slate, or cementitious mortar, or any combination of the two. Repairs using the wrong materials can make the slate and the lime backing unusable, potentially widening the areas of failure and rendering good slates unsalvageable.



The change in colour of the slate on the chimneystack in the background indicates where a number of courses were removed and replaced. In areas of extreme weather exposure, vertically hung slating gives increased protection to the stacks

REPAIR OF A SLATE-HUNG ELEVATION

Wholesale replacement of vertically hung slating can alter the appearance of a building, and planning permission may be required before such works may be undertaken. Where there are patterned courses of slate or specialised detailing, these should be replicated, and particular care should be taken to save and reuse any shaped slates.

Replacement vertically hung slating should be carried out in the traditional manner, fixing slate using lime putty mixed with sand applied onto the masonry walling. Where new fixings are required for the re-hanging of vertical slates, opinion is divided on the use of stainless steel nails or clipped fixing over a large area. Modern mild steel nails rust too quickly, but a stainless steel proprietary fixing, though resistant to corrosion, does not bond with the mortar in the way that a traditional wrought iron nail would. This is due to the initial rust skin on the wrought-iron nail which bonds with the mortar. Wrought-iron nails can still be obtained through specialist suppliers to the marine trade. They will eventually corrode, but over a considerable time. The traditional lime-mortar bed and the snug fitting of the head lap of adjoining slates

provide the main adhesion to the wall, the nail fixing is therefore of more importance while the lime-mortar bed cures. If proprietary, mechanically driven stainless-steel nail fixings are used to fix the head of the slate, this should be carried out by personnel experienced in such delicate work.

The modified practices of fixing vertically hung slating to treated timber battens on felt with copper nail fixings, or to treated timber battens set into lime, are not recommended for historic structures and may be prone to more rapid deterioration than traditional detailing. A major disadvantage is that the batten fixing method requires a weather detail at the exposed edges to cover the space left between the new slate and the wall. This weathering detail alters the appearance and depth of the original slate fixing. Timber battens also need to be fixed to a flat and regular wall, whereas the traditional fixing method was able to take up the soft undulations of historic masonry. The more regular fixing onto straight battens is likely to result in a very different aesthetic to the original slate hanging, one which by contrast is flat and dull in appearance.

REPAIR OF SLATE CONICAL ROOFS

The repair of slated circular or half-round shaped roofs is best undertaken by a roofing contractor who has experience and skill in gauged work with conical roofs, supported by the advice of a slating specialist for the cutting and sizing of the replacement natural slate. If the roof needs to be re-slatted, slates should be removed carefully and numbered according to the courses from which they were removed. Replacement slate should be sourced as previously outlined. Where new slating is being considered, it is important to note



The repair of curved slate roofs is highly specialised work and requires a roofing contractor who has experience and skill in gauged work

that many of the slating norms and codes may not apply to this roof design, for example, the minimum standard for headlap and side lap may not be achievable, or roof pitches may be lower than is generally recommended. Typically the largest slate which can sit flat on the curve is installed at the eaves in the setting out of more generous circular forms. The slate layout to a conical or curved roof plan may vary from the slate headlaps or pattern on the main roof. The slates to a conical roof are cut with a taper so they can be fixed snugly together. The slating supplier may be able to provide slates cut to the required shape, based on the setting out of the roof, the circumference and size of slate chosen. In most curved bays or conical roofs the slates will be fixed directly to a sarking or boarding. This boarding, along with the structural members, should be checked to ensure no sagging has occurred in the substructure so that the circular form remains as smooth as possible, with well-set slates.

Curved roofs with tight diameters may be covered with graduated and random-width slates and finished with a top capping section in lead or copper, as it may not be physically possible to slate out to the full height of the roof. When approaching a slate course with less than twenty slates, unseen copper soakers may have to be introduced into the headlap to prevent the use of too much lead or copper material and to ensure a visually pleasing form. The side lap can also be adjusted every third course by the omission of a slate.

Stone slab repair

Many surviving stone-roofed buildings in Ireland are either no longer inhabited or were from the outset built as outbuildings. Stone slab roofs are a major contributor to the character of these vernacular buildings; they are attractive and can be put back into good working order by using appropriate materials and best practice repair details. Luogh or Moher flags can be obtained for roofing repairs from local quarries in County Clare. It is difficult, however, to obtain matching stone for roofs outside these areas. Slabs and flags for repair works should not be taken from standing buildings, which may themselves be of historic interest.

If lime parging has fallen off from beneath the slabs it should be repaired on a like-for-like basis, particularly where stones were pegged. Originally, the parging sealed the roof and held the fixing pegs in place, so

the repair or restoration of lost parging is recommended for stone slab roofs on grounds of performance. New pegs for fixing should not be made from green wood, as they will shrink and loosen.

Copper pegs can be used, although where the original holes are larger than the diameter of the original peg, it is recommended to use a larger peg or washer to lock the stone slab in place.



Most buildings using stone roofing slate are distinguishable by their simple gable-ended roofs. Hipped profiles, dormer windows, and valleys are difficult to achieve because of the large and somewhat unwieldy nature of the stone slate

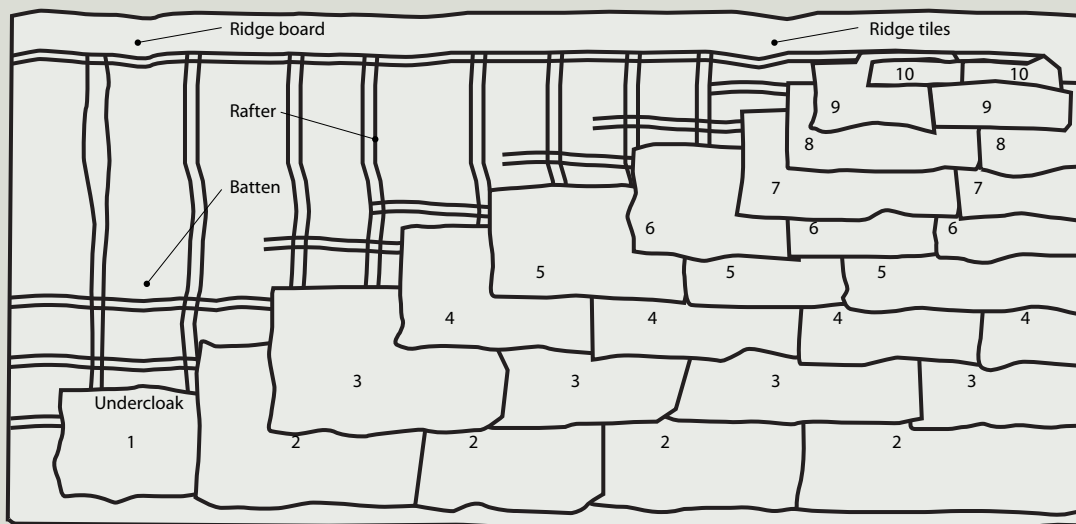

Graduated stone slates
Note: the distance between the battens decreases towards the top of the roof

Diagram illustrating graduated stone slabs. Note that the distance between the battens decreases the further up the roof they occur. The battens are placed to suit the stone available rather than attempting to suit the stone to the batten spacing. If a stone roof covering has to be removed during repair work, it is important to store the courses together as it makes reassembly easier. Flags or stones are shown numbered, indicating the courses for sorting. It is important that the headlap remains the same at each course

Clay tile repair

REPAIR AND REPLACEMENT OF BROKEN CLAY TILES

Good quality clay tiles have a lifespan comparable to that of good quality slate; they can be reused if carefully salvaged and, like slate, can survive in good condition if well maintained. New clay tiles are estimated to have an average lifespan of 80 to 100 years. Typical defects of clay tiles are breakage caused by impact or faults in the original clay composition, firing or fitting of the tile, which result in stress within individual tiles, leading to cracking. Best quality clay tiles have a slightly higher rate of water absorption than slate and perform the same weathering function well. Poorer quality clay tiles are affected by frost damage over time, particularly at changes of pitch, as tiles laid at lower pitches are more prone to becoming saturated with rainwater, which expands on freezing, cracking the tiles. This deterioration can often be seen in the lower rows of exposed tile, which vary in colour and tend to accumulate plant growth. Single-camber plain clay tiles tend to retain water at the tails due to capillary action and are therefore more susceptible to frost damage.

Under-burnt tile is not a common defect in Ireland, but where under-burnt tiles are sourced from continental Europe, they may not prove capable of withstanding the wetter climate here. Under-burnt tiles, over time, become porous and more prone to degradation. They appear pale in colour and their texture can be sandy. The hammer test (checking the integrity of a tile by listening for the sound it makes when struck a blow) can be undertaken with tiles as with slate; a degraded tile will not ring true.

The roof should be surveyed before work starts, identifying and recording the location of courses of ornamental tiles such as bull nose, fishscales, clubs, and other specials such as hip bonnets and hip arrises which contribute to the character of the building. Glazed interlocking tiles are sometimes used on an otherwise unglazed roof in the abutments or eaves, in the same manner as undercloaks. This pattern should be retained where a roof is being replaced or repaired. Clay finials such as fleur-de-lys, Granny Bonnets and arris hip tiles, as well as valley tiles and vertical angle tiles, are all part of the character of a historic clay tile roof. These features should be retained and repaired as far as possible or carefully replaced where necessary.



A gate lodge with a decorative clay-tiled roof, having striking curved elliptical eaves and a patterned use of plain and scalloped tiles. Overhanging branches and the proximity of large trees have tended to promote extensive moss growth on part of the roof

CLEANING OFF MOSS AND LICHEN GROWTH

A sand-faced or handmade tile will tend to attract moss and lichen growth, particularly on parts of roofs overhung with branches and in wooded areas. Moss and lichens should be removed as they can hold moisture against the surface of the tiles, causing saturation and a potential for frost damage. The run-off from the organic acids they produce can erode the surface of tiles. This acidic run-off can also cause the fixings to disintegrate. The use of high-pressure water hosing to clean a tiled roof should not be attempted, as it can dislodge the tiles and allow water to enter the roof, where it has the potential to cause considerable damage. A copper strip attached near the ridge of a roof can help prevent or delay moss and lichen growth. An alternative treatment is the application of a proprietary moss-removing product. A trial test on an unobtrusive area of the roof should be carried out in advance to ensure that no damage is caused to the tiles.

REPLACEMENT OF INDIVIDUAL TILES

Occasionally, interlocking tiles are fixed vertically (up the pitch) and not horizontally, making it relatively easy to remove individual broken or damaged tiles. Depending on the weight of the tile, the technique illustrated in the adjacent image could be considered for a single tile replacement where the fixings have slipped. The benefit of using a copper or stainless steel hanger, as shown, is that there is no 'tingle' or visible metal strip.

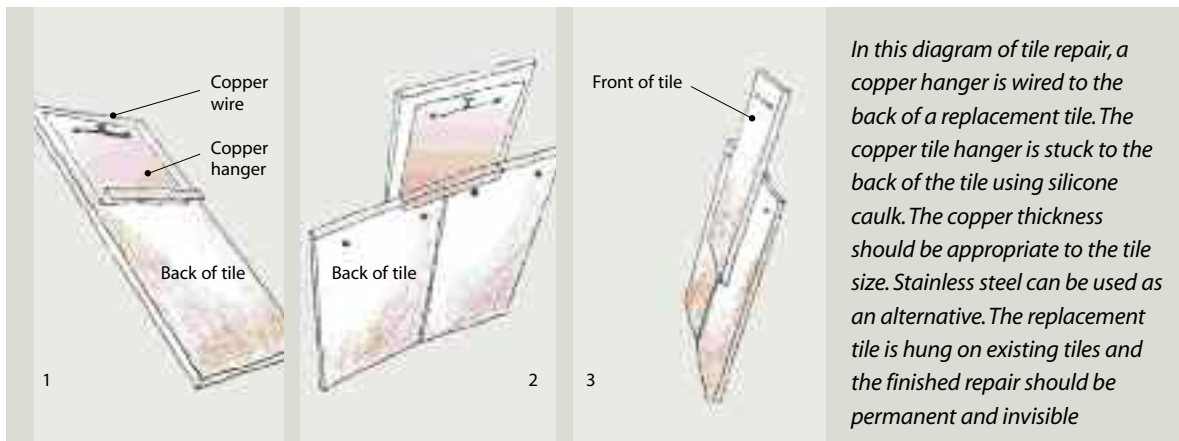

REPAIR OF TILED ROOFS

The methodology for re-covering a tiled roof differs from that for re-slating a roof. It establishes a different sequence of work to avoid damage to the newly placed tile. The tiles are hung over timber battens and not every tile is individually fixed. Firstly the tiles to the eaves row are placed, then the verges and roof features such as dormers and around the base of the chimney stacks. The remaining areas of roof to be covered are filled in from the top down, to avoid walking on fixed tiles. The security of the fixing and installation of the tiles depends on the overall weight and integrity of the covering. Fixings can be located every third row or as sparsely as every fifth row, depending on exposure, tile type and roof slope. The non-fixed tiles literally hang off the timber battens from the projecting hanging edge to the rear of the tile.

To successfully repair damaged vertically hung clay tiling, the tiles directly above the damaged tiles should be stripped out from the top down in a 'V'. The damaged tiles can then be removed and replaced. When fixing replacement tiles, the fixings should go into fresh timber. Nails or screws of larger diameter than the original nails should be carefully used, so as not to split smaller battens while ensuring a good fix. Every vertically hung tile should be nailed securely.

The salvage of existing tiles for reuse should be carried out with great care to ensure that they have a similar life expectancy to any new tiles added to make up the shortfall. If an existing tiled roof has specific weathering defects or is suffering symptoms of tile aging, replacement of the whole covering with a similar tile may be necessary, and planning permission may be required.

SOURCING REPLACEMENT TILES

The major issue with single tile replacement occurs with the variety of clay tiles available for selection. Replacing a handmade clay tile with a machine-made one is generally not acceptable, as it will differ in character and appearance from the originals. For larger areas of repair work it may be difficult to source a sufficient quantity of tiles. Many of the more modern plain tiles are readily available from suppliers. However, 'specials' (shaped or decorative tiles) can be more difficult to source. There are extensive ranges of continental clay tiles with finishes to the tile such as glazes or slips (applied before firing at a much higher temperature to form a molten glass coating on the face of a tile). However, the long-term performance of these tiles in the damp Irish climate should be ascertained before using them. It is possible to have new tiles made to match existing roof tiles, depending on the significance of the building. The sourcing of such 'specials' is through English companies which historically exported tiles to Ireland in the nineteenth century.

As modern gas kilns cannot replicate traditional tile colours, localised repair using a salvaged tile may be the best option if the colour of the original tile is a distinctive characteristic, and where matching new tiles are impossible to source.

Some roofing salvage yards hold large quantities of clay and concrete tiles as well as decorative clay ridges. As well as local dealers, quantities may be available in foreign salvage yards. Online facilities can be used to source historic tiles, many of which were more commonly available or are found in larger quantities in England. A sample of the matching tile should be requested, and the supplier's yard visited, to

check the tile condition, colour, size and general suitability before making a purchase. It is important to establish the provenance of any salvaged tiles to ensure that they have not been taken from another historic building that should not have been demolished in the first place.



There is a wide range of clay ridge tiles available, including ornamentals, which enhance the character of a roof. These should be repaired or replicated as necessary, but not introduced unless there is evidence of their use on the building

When trying to source appropriate replacement tiles, photographs can be a convenient way to circulate information on the existing tiles to be matched. When providing photographs of an existing roof tile to potential suppliers, every attempt should be made to depict the measurements of the tile accurately by using rulers or tapes to measure them within the image; a sketch noting the exact measurements should also be provided.

Concrete tile repair

The lifespan of a concrete tile is not as long as that of a clay tile, particularly in the case of ridge tiles, which become more porous over time. Concrete tiles weather, making single tile replacement difficult unless a reclaimed tile can be sourced which has a similar weathered appearance. The standard size is 15 x 9 inches (380 x 230mm); while a few are 18 x 10 inches (460 x 255mm). Care should be taking when sourcing replacement tiles to establish whether a left-handed or right-handed tile is needed. This is because the interlocking part of a tile can be handed, or turned back to front. The tile may appear identical in all other respects.



A Marley concrete roof tile on this modest 1940s cottage

MAJOR REPAIRS

Where the condition of a concrete tiled roof is so poor that stripping and re-tiling is considered necessary, the roof should first be surveyed and photographed to ensure that the existing details will be properly replicated. It is important to salvage as many as possible of the sound tiles for reuse. These should be carefully selected, cleaned and mixed with new tiles to ensure a good colour blend. When carrying out an alteration or extension, the old concrete tiles could be stripped from the rear of the roof to make up a shortage on the front pitch, using similarly weathered tiles for the sake of uniformity.

Lead and leadwork repair

Lead is the best material for weatherproofing complex roofing details and junctions which cannot successfully be made watertight over the long term with any other roofing material. However, leadworking requires considerable expertise. Lead has a high coefficient of thermal expansion. This means that it expands when heated and contracts when cold significantly more than other adjacent building materials, and by as much as three times more than brickwork. Lead is often positioned in parts of a building that are subject to the greatest range of temperature changes such as roof surfaces. Therefore, good detailing and work practices are essential to ensure that thermal movement in sheets of lead does not cause opening of joints or splitting of the sheets. The weight and low strength of lead sheets can also, if not correctly detailed, result in tearing at fixing points, or in creeping and sagging of sheets, particularly where fixed to steep pitches or used as vertical flashings.

WORKING WITH LEAD

Lead has been used in construction for centuries. However, lead and its corrosion products are hazardous to health and it is essential to take precautions when working with the material. The Lead Sheet Association provides helpful advice on the safe use of lead which can be downloaded from www.leadsheetassociation.org.uk.

Lead is very dense and therefore even the smallest sheets and rolls of new sheet can be exceptionally heavy. Proper lifting equipment should be made available to assist in the lifting of any weights over 25kg. Lead when ingested can build up in the body to toxic levels; therefore it is essential not to eat, drink or smoke in a place liable to be contaminated by lead and to wash thoroughly at the end of each working session. Likewise, gloves should be worn when working with lead to prevent fragments becoming embedded in the skin.

When lead is heated it can begin to fume at temperatures above 500°C. Hence, when lead welding it is essential to wear masks and to only heat lead in well ventilated areas. In certain conditions lead can corrode, forming lead carbonate in the form of a

hazardous white dust. Therefore, masks must be worn when removing old lead sheeting and the lead sheet must always be handled with the utmost care. All old lead sheet and any off cuts generated during the works should be collected, segregated from other materials and disposed of safely or recycled.

PUNCTURES AND GASHES

Lead is a soft material that is easily damaged and torn if subjected to heavy foot traffic. Punctures and gashes from walked-in nail heads or slipped slates are the simplest types of damage to repair. Short-term repairs can be made using a proprietary sealing tape or by soldering/solder wiping. Lead soldering involves either dropping solder onto the damaged area (which has been prepared using flux) or soldering on a small lead patch. A soldered repair has a smooth wiped look. Because the solder is formed of approximately two parts lead to one part tin, it can behave differently from the base lead, and thus a soldered repair should always be regarded as temporary. However, soldering can produce an effective repair without the use of excessive heat, thus avoiding the risk of burning through the lead sheet and damaging not only the sheet but the substrate below.

Lead welding (traditionally called 'lead burning' and not to be confused with soldering) is a skilled job and should be carried out by an experienced lead worker. To reduce fire risks, lead welding, or indeed the application of any heat on a building, may be banned on many sites or subject to permits and agreed working procedures. If the lead is old and has suffered from metal fatigue or crystallisation (see below), lead welding will not be successful. Hot work at roof level, where permitted, should only be carried out by a skilled operative and carefully monitored, as it may continue to smoulder. The area of work should be carefully monitored for an extended period of at least 24 hours in order to detect as early as possible an outbreak of fire.

PROBLEMS WITH SUPPORTING TIMBER STRUCTURE

Sometimes damage to lead sheeting has been caused by the subsidence or failure of the supporting timbers. This can be identified by areas of water ponding away from the rainwater outlets or by soft spongy areas where the gutter or roof deflects noticeably underfoot. The timber boards may have deteriorated due to an ongoing problem with the supporting substructure, or a badly functioning rainwater outlet causing water to back up and to overflow the lead linings. In these instances the design of the leadwork may not need altering, but the sheets or gutter linings will have to be lifted where necessary to allow repair below. The reuse of the old metal sheeting may be possible, but frequently the lead in the damaged area will need replacing. Where the problem has been attributed to a blocked outlet, the rainwater disposal system should be investigated, as it may need repair or local redesign. The fitting of an overflow pipe should be considered, as this will give a warning if future blockages occur.



Ponding of water away from gutter outlets indicates a problem with the substrate timbers. In this case, a likely cause was poorly functioning flashings at the junction with the parapet wall

LEAD CORROSION

Although lead is generally highly resistant to corrosion it is not immune to it. The principal environments in which lead is likely to corrode, albeit slowly, are discussed below.

Acids, either from atmospheric pollution (possibly generated locally from a chimney on the building itself) or from organic growths such as lichens and moss, can attack lead. Where there are drip points such as the end of a slate over a lead gutter, corrosion appears either as grooves or circular patterns on the surface of the lead. After several years this corrosion can eventually penetrate the lead. Sometimes the corrosion forms a powder with discolouration on the surface, which is apparent as an uneven ridged texture if a (gloved) finger is run across the surface. If the problem is severe, replacement of the lead will be required; however, the rate of corrosion is usually slow. This type of acidic corrosion can be avoided by fitting sacrificial lead flashings of a lighter code of lead tucked under the slates and held in place with clips (in time they will need to be easily removed). These additional flashings, which take the full force of the destructive run-off, protect the main flashing below. If the acidic run-off is caused by lichens or mosses, fitting copper strips higher up a pitched roof causes a toxic wash which kills the organic growth and prevents re-growth. Alternatively, a solution can be applied (which is more suitable to a flat roof) that kills the organic growth and prevents re-growth for a considerable time. The choice of solution should ensure that it is suitable for use on roofs and will not cause additional problems, particularly to other adjoining roof finishes.

The alkalis present in lime and cement mortars can initiate a slow corrosive attack on lead used as a defence against water penetration, for instance where a lead damp-proof course is placed below a porous stone coping. It is possible to find lead under stone copings which has been so badly affected it looks like moth-eaten cloth. To protect against alkali attack, a thick coat of spirit-based, cold-applied bitumen paint should be coated on all surfaces of lead sheets built into masonry which are in contact with lime. An underlay sheet should also be used, to allow the lead to move freely with temperature changes. Flashings turned not more than 50mm into mortar beds or chases in masonry do not need bitumen or underlay, as the carbonation of free lime is rapid, minimising the risk of corrosion of the lead.

Many masonry cleaning agents contain hydrochloric or hydrofluoric acids which can corrode unprotected lead if they are allowed to lie on the surface of the lead.

The organic acids present in hardwoods, particularly in oak, can cause the gradual corrosion of lead. This corrosion can be exacerbated in situations where condensation forms on the underside of the lead sheeting and takes up acid from the boards. Where oak or cedar roofing shingles or hardwood external joinery (for example sills on roof dormers) are used in conjunction with lead flashings and gutters, a sacrificial flashing or coating of bitumen paint will protect the lead until the natural weathering of the shingles has leached out the free acid.

UNDERSIDE LEAD CORROSION (ULC)

Underside lead corrosion is perhaps the most insidious and hazardous form of lead corrosion. In heated buildings, warm moist air rising up from inside the building can condense on the cooler underside of lead sheeting where there is insufficient ventilation. This may happen more readily on south- and west-facing slopes in comparison to the more shaded northern slopes, as rapidly alternating sunshine and cloud can lead to the distillation of trapped moisture. It can lead to a thin coating of white corrosion deposits forming on the underside of the lead sheeting, which is not a problem for the long-term performance of the lead. However, when large amounts of condensation occur, a thick layer of white lead carbonate can form, and in extreme conditions, corrosion can penetrate through the lead. The usual signs are white streaks running out from under lap joints (not to be confused with run-off stains). Lifting the lead (with a gloved hand) will reveal the underside coated with a white powder. This is a highly toxic material.

ULC may be exacerbated by the action of organic acids if the lead is laid on oak boards, manufactured timber products such as plywood or an organic underlay. Some acids can be corrosive when damp. If the lead was laid onto wet boarding and underlay during construction the problem can be more severe. Although ULC has been known to plumbers for centuries, in recent times incidences of more severe corrosion are thought to be increasing, possibly as a result of the increased use of central heating and reduced levels of natural ventilation in buildings today. Painting chalk paste (a slurry of chalk powder in water) on the underside of new lead just before each



Slight lead corrosion can be seen on the exposed underside of the lifted lead sheeting on the right. The main problem here was a poorly detailed gutter. There was no need to change the regime of the flat roof, although good practice would include an underlay between the deal boards and the sheet lead

sheet is laid has shown some positive results in limiting ULC, but it requires two applications and is a difficult operation, particularly on steeply sloping surfaces.

Adapting the roof to what is termed a 'cold roof' may help to reduce ULC. This requires an air and vapour control layer to stop water vapour getting into the ventilated space under the lead, and also ventilation of this space to the outside only. Generally, if the corrosion problem is extensive and severe, consideration should be given to the redesign of the roof structure to form a 'ventilated warm roof.' This is a type of roof structure more successfully used in new construction than in conservation, as it requires changes to the roof profile.

REPAIRS TO THE TIMBER SUBSTRATE

White deal boarding was the traditional substrate for lead sheeting and is still considered one of the best and should be retained wherever possible. On a steeply sloping surface the lead can be laid directly onto the boards. When laying new lead sheeting in areas of shallow falls, an underlay of needle-punched, non-woven geotextile felt should be used between the boards and lead to avoid the lead adhering to resins or joints in the timber. Felts containing bitumen should not be used, as heat could make the bitumen stick to the lead sheeting. Building paper suited to plywood should be used.

LAYOUT AND SIZING OF NEW LEAD SHEETS

If it is necessary to replace the lead finishes to a roof or gutter, the effectiveness of the existing layout should be assessed to check if the original layout included enough outlets or used appropriate lengths and codes of lead. If this is the case, the replacement of leadwork should be on a like-for-like basis. Although milled lead is the more commonly available product, on high-quality projects the use of new sand-cast lead sheet should be considered where the original sheets were sand cast, and if this appearance is important to the character of the leadwork.

Valleys and valley gutters should be laid to good falls, be easy to walk along for maintenance and have sufficient outlets to ensure the quick disposal of rainwater. Overflows should be placed where they will be noticed if hidden gutters or hopper heads block up. In buildings with significant interiors or contents, moisture-sensitive alarms should be considered for installation underneath internal or hidden valleys.

The replacement of lead to flat roofs and to valley and parapet gutters with a cheaper, modern synthetic material is a misplaced economy. A well-repaired roof should have a life expectancy in excess of fifty years; hence, it is wasteful to use shorter-life materials which will have to be replaced long before the other roofing materials and would require disruption of sound slates, nails and battens. It should be noted that lead sheet is a totally recyclable material, unlike synthetic roofing materials.



The design of this parapet gutter has been revised to achieve correct lead sheet lengths, falls and step heights in order to ensure that the newly-laid gutter will achieve a good lifespan. Note that the lead sheets have been fixed at the top end only (to allow for expansion and contraction), using copper nails in a staggered pattern



Welts to lead flashing to the vertical face of the parapet wall. Note the steps in the lead gutter and the rolls in the lead apron on the lower portion of the roof slope

LEAD CODES

The number codes for identifying new lead represent the number of kilograms per square metre, a measure of density rather than thickness. For instance, Code 6 lead weighs approximately 30 kilograms per square metre. Sand-cast lead sheet is typically from 2.65mm and up to 5.3mm thick at 60 kilograms per square metre. Rolled and machine-cast lead sheet is generally between 1.32mm and 3.5mm thick, but can sometimes be supplied up to 4.4mm thick. To assist with identification on site, the classifications are also colour-coded.

Falls to lead-lined gutters and flat roofs should not be less than 1:80. This amounts to a minimum drop of 25mm over 2 metres. Drip heights (the steps at joints in sheets down the slope) should be a minimum of 60mm for historic buildings. Where sheets need to be joined across the width or fall of a gutter or roof, then wood-cored rolls should be used. On pitched roofs and wall cladding, hollow rolls, welts or standing seams can be used. New leadwork requires coating with a



New lead flashing over lead soakers, turned into a mortar joint in the stonework at the base of a chimneystack and fixed using lead welts. The mortar joint is yet to be repointed

patination treatment as soon as practicable after fixing, and no later than at the end of the day's work. This will avoid unsightly white stains occurring on the work below.

Table 1: Lead codes

Code no.	Thickness mm	Weight kg/m ²	Colour code
3	1.32	14.97	Green
4	1.80	20.41	Blue
5	2.24	25.40	Red
6	2.65	30.05	Black
7	3.15	35.72	White
8	3.55	40.26	Orange
10 Special	4.48	50.80	Special - not colour coded

Table 2: Lead codes recommended for use on pitched roofs of historic structures, extrapolated from the Lead Sheet Association handbook

Specification and design considerations	Thickness of sheet for uses on historic structures	
Durability of lead will depend upon the thickness and size of the piece of lead sheet.	Type of application	Code Number
When specifying thickness also make allowances for:	Soakers	3 or 4
Anticipated life of building	Apron and cover flashings	5, 6 or 7
Vulnerability to wind lift	Damp-proof courses	4 or 5
Mechanical wear due to foot traffic	Weatherings to cornices, parapet walls	6 or 7
Risk of moss or lichen growth	Pitched valley gutters	6 or 7
The use of thicker lead in longer pieces can be more economical than using thinner material with additional joints, particularly when detailing gutter linings	Hip and ridge flashings	6, 7 or 8
Consider ventilation of the void between the substrate and insulation	Lead slates	5 or 6
If using lead sheet as a damp-proof course, then both sides should be treated with bitumastic paint	Chimney back gutters, aprons & side flashings	5 or 6
Rolled lead sheet should comply with Irish Standard IS EN 12588:2006.	Dormer roofs	6, 7 or 8
Sand-cast sheet should comply with manufacturers' Agrément certificates.	Dormer cheeks	5, 6 or 7
All installation of lead should comply with BS 6915	Vertical cladding	6 or 7
	Pitched roofs	7 or 8
	Parapet, box and tapered valley gutters	6, 7, 8 or 10*
	Flat roofing	7 or 8
	* In certain instances, the longer lengths allowed for Code 10 may suit the steps and falls of the valley better, but note that this lead is exceptionally heavy and hard to work	

Table 3: Lead codes, lengths and widths recommended for use on flat roofs of historic buildings

Code Number	Flat and pitched roofs up to and including roofs of 80 degree pitch		Parapet, box and tapered valley linings	
	Maximum spacing of rolls/seams across the fall (mm)	Maximum distance between drips/laps (mm)	Maximum overall girth (mm)	Maximum length between drips (mm)
6	-	-	850	2250
7	675	2500	900	2500
8	750	3000	1000	3000
10 Special	750	4000	1000	4000

LEAD THEFT

Lead theft is not a new problem as its value, combined with the ease with which it can be melted down and recycled, has always ensured a high second-hand price. Most vulnerable to theft are lead statues and garden ornaments, but roofing lead is not immune, particularly that on isolated buildings such as rural churches. One of the most likely times for the theft of roofing lead is during construction works when scaffolding is present and/or a site is left unattended, where old sheets have already been lifted ready for removal or replacement and new lead rolls are waiting to be used. Adequate security should be provided for the duration of the contract to prevent the theft both of existing leadwork and new materials stored on site.



The theft of lead and copper from a historic roof can cause significant damage and leaves the interior of the building vulnerable to further damage from flooding

Copper sheet repair

The installation and repair of copper sheeting is a skilled trade. The thermal expansion of copper is half that of lead, which means that problems arising from thermal expansion and contraction are significantly less, but should nonetheless be anticipated.

Splits in copper sheeting can result from thermal movement, particularly if the sheet has adhered to the substrate. Alternating wind suction and pressure can cause metal fatigue in the lightweight sheeting, resulting in cracks or slight fissures. Torn or loosely fixed copper should be repaired as soon as possible, as the wind can lift the lightweight material or even blow it off the roof.

Where copper roofing has split or cracked, small repairs can be executed with a copper patch soft-soldered over the defect; larger patch repairs cut with a dog tooth edge can also be executed, but the damaged sheet needs to be lifted off the substrate to allow a fire insulating pad to be laid underneath. Thus it usually makes sense to weld in a new section to replace the damaged part, or to replace the affected sheets in their entirety. If the adjoining original sections of copper have hardened and lost their malleability, these sections will also need to be replaced, or a step introduced to allow the new to be joined to the old.

Although copper is generally highly resistant to corrosion, a few specific problems can occur. Copper can cause corrosion to other metals such as iron, aluminium or zinc when it comes in contact with them or if rainwater from the copper roofing runs off onto other metals. Copper has little effect on lead or stainless steel. Copper is in itself not corroded by other metals, but it can be stained by rusting iron and steel or acid run-off from some trees. Copper, unlike lead, does not suffer from underside corrosion.

The flow of acidic water over a small area of copper, often called 'erosion corrosion,' occurs when large volumes of rain water run off an inert material such as slate or tile onto a specific point on a copper roof or copper-lined gutter. Bright salmon-pink areas on the copper indicate that corrosion is occurring. Newly laid copper sheet may deteriorate before it can develop a



This copper parapet gutter lining has been lifted for inspection following water penetration problems. The bright salmon-coloured areas indicate that corrosion is occurring. Holes in the copper had been previously filled with a bitumen product in an earlier repair attempt which has exacerbated the problem, as bitumen corrodes copper



Re-lining a valley gutter in copper. Splice repairs were required to the ends of rafters where the previous valley had leaked over a significant length of time, causing decay of the timber structural elements below



Parapet gutter re-lined in copper. The very shallow falls to this gutter precluded the use of lead

natural protective patina. Erosion corrosion can be made worse by run-off from timber shingles and bitumen coatings exposed to the sun. The remedy to this situation may be to insert a sacrificial flashing above the main flashing.

The chlorides in fresh mortar can be aggressive to copper and can react to form copper chloride. In coastal areas, salt spray will form soluble copper salts, which then leach from the copper surface, exposing more copper to be attacked. This process may lead to a blue-green stain forming on nearby light-coloured surfaces such as stone or render.

Copper is particularly useful for the redesign of poorly executed tapered valley and parapet gutters where the falls are insufficient to allow the use of leadwork. Copper sheets laid to the traditional system, fixed with soldered double-lock welt seams, can be laid successfully to very shallow falls as soldering the seams means that steps are not required at the joints of sheets. Alternatively, copper can be laid to the more modern long strip system. Whichever system is deployed, the gutter will need expansion joints, typically at 7 metre intervals for a 300mm wide gutter of 0.6mm thick copper. These lengths can be increased by using a greater strength of copper or by increasing the thickness of copper used to 0.7mm or even 1.0mm thick, but sheet lengths should be decreased with a wider gutter.

PATINATION OF COPPER SHEETING

Copper oxidises naturally through a process of colour change to a distinctive matt green patina. This can be either accelerated or prevented by chemical means to match existing sheeting, although it is difficult to achieve uniformity over large surface areas. There are techniques for bringing about the patination of small areas of copper repairs. Copper sheet can now be supplied pre-patinated, which could be useful when repairing existing aged or patinated copper structures. Boiled and raw linseed oils were traditionally used to retain the natural bright copper finish. However, both have drawbacks; for example, raw linseed oil has a long drying time. A modern alternative is high-grade paraffin oil. Whatever oil or proprietary product is chosen will need reapplication periodically and may not prevent all staining.

Zinc sheet repair

Zinc sheeting is fitted and repaired in much the same way as that of copper and, like copper, the installation is a skilled trade. Most roofers who work with copper can also work with zinc.

Zinc is fairly corrosion-resistant (it is the material used to galvanise iron), but it is susceptible to atmospheric pollution from coal and wood fires. Like most metal roofing materials it can be eroded by the acidic run-off from timber shingles and it will also suffer corrosion in the presence of copper. Care should also be taken when building in zinc flashings to avoid local corrosion from the alkali products in lime mortars.

Zinc may be considered as a replacement for lead in areas where the use of a light-weight material of similar colour to lead is required and where substitution with copper would dramatically alter the appearance of the roof. It should be noted that zinc does not last as long as either lead or copper, and its colour and patina are not identical to lead. Care should be taken to ensure that it is an appropriate substitute material for the structure in question.

Re-roofing flat roofs

The use of asphalt and bitumen repairs to a roof is not recommended, except where this was the original detail or as a temporary or holding situation. However, there may be exceptional instances where a flat roof is presenting unsatisfactory weatherproofing details, particularly at the parapet or eaves overhang, and cannot be successfully repaired using sheet metal finishes without a change to the historic detailing. In these instances, hot rolled asphalt may be an option. Expert advice should be followed. This roofing product has been in existence for over 100 years and is a tried and tested solution for flat roofed areas that are tricky to successfully weatherproof. Asphalt can be laid to roofs with little or no fall to a total of approximately 30mm build-up of finishes.

Corrugated iron repair

Corrugated-iron roofs, whilst originally assumed to have a relatively short lifespan, have in instances lasted over 100 years. The galvanised (zinc) coating on corrugated sheeting plays an ongoing role in its protection. When the zinc layer is newly scratched or the sheet is cut, fresh uncorroded steel and zinc are exposed. In the presence of water the zinc corrodes sacrificially to the steel. The corrosion products of zinc are relatively stable, so they provide protection to the steel. However, this process thins the zinc layer and eventually, as the zinc is lost, the zone of exposed steel becomes broader and ceases to be protected. It is then that the steel corrodes and repair is required.

The life of a corrugated-iron roof will be extended by keeping the roof clean. Pitched roofs are more or less self-cleansing, but those of a shallow pitch such as porches and valleys should be swept clear of debris. Any debris will trap water and lead to accelerated loss of zinc and paint.



This corrugated iron is suffering from pitting, visible as small pinpricks of light where the metal has corroded through. There is also crevice corrosion occurring at the junction of the sheet with the hip roll. In addition, work is urgently needed to repair the rainwater goods

PROBLEMS AND SOLUTIONS

The patching of small holes can extend the life of a sheet and delay its replacement until other sheets need attention. Patches of lead can be soldered over the holes or silicone used locally to fill very small holes prior to repainting. However, the use of silicone in an external setting is a short-term solution, as it is liable to lift if the paint seal breaks and the metal becomes damp.



Crevice corrosion is frequently a problem with corrugated iron, particularly at the laps between corrugated sheets

More extensive corrosion of sheets and fixings is often associated with water penetration at the fixings or crevice corrosion from capillary action of water where the sheets lap. The insertion of a small additional lap length of new sheet between the two existing sheets, extending approximately 100mm beyond the joint, will give additional longevity to the roof without the need for replacement of several or all of the sheets. However, in some instances it may be necessary to dismantle the roof in order to treat the crevice corrosion successfully.

Damage to sheets at eaves level can be temporarily repaired by inserting a short length under the existing sheets, allowing sufficient overhang to reach the gutter or to provide a good drip. It may also be necessary to replace a section or an entire sheet.



The eaves edge of corrugated-iron sheeting is particularly vulnerable to corrosion. Here, additional layers have been inserted under the eaves

The removal of fixings is necessary for most repairs and should be carried out with care to avoid localised crushing of the sheets. If the fixings are still robust, a protective timber board should be placed across the crests of the corrugations as leverage for a hammer or nail bar claw against whilst clawing out the original fixings. Where the fixings are less robust, the head should be carefully knocked off and the rest of the nail punched through into the timber structure. Replacement fixings should be of galvanised mild steel and should match the original in shape as closely as possible. However they may need to have a slightly wider or longer shank to ensure a good grip within the previous hole in the timber structure. Different-sized

washers or a flexible under-washer should be considered to ensure a more weatherproof fixing detail. Washers larger than the original ones should only be used if necessary, as the different fixings will be visible.

PAINTWORK

Protection of corrugated iron with a paint finish is essential to maintaining a long lifespan, as it reduces the chance of corrosion pitting the galvanised sheet. The vulnerable lower edges at eaves level need particular attention when painting, as does any corrugated iron that will be in contact with lime or cement products, such as when reinstating a gable coping. Traditionally, corrugated iron was painted with red lead or iron oxide paints giving a distinctive dark red colour, while another common colour was a dark green. Careful analysis of the existing layers of paint in an area where the paint coating has been subject to little wear can be used to obtain an indication of the historic colours. In taking paint samples, it is of utmost importance not to scrape any remaining galvanised layer off the metal.

Care should be taken when preparing the surface of galvanised corrugated iron for painting. Paint that is adhering well should be left in place and just rubbed down. However, it is essential that all rust is removed, otherwise corrosion will continue beneath the new paintwork.

Iron oxide paint is not a particularly good rust inhibitor (it was predominantly used as a wood preserver and in all likelihood began to be used on corrugated iron roofs merely because of its wide availability on farms). Red lead paint was traditionally one of the most common primers used for iron and is still widely available, particularly from chandlers. Unlike paint containing white lead, there are no restrictions on the use of red lead as a paint. Re-painting with a modern paint type such as a micaceous iron oxide is a viable alternative. It can be used for the primer and main coats, although the range of colours is limited. The historic colours should be matched as closely as possible. Paint supply companies are best placed to advise on suitable paint systems for particular applications. More detailed information on paints and the preparation of iron and steel for painting can be found in *Iron - the repair of wrought and cast ironwork* in this Advice Series.

NEW IRON SHEETING

Historic corrugated iron in Ireland is generally of a regular wave pattern at 3 inch (75mm) centres. Sheet was supplied in sheets of 8 corrugations in width (2 foot or 600mm) and lengths of between 4 and 10 feet (1.2 and 3 metres). New sheets with a matching

corrugation pattern should be used, and fixed in place using the original nail holes where fitted over existing sheets. The new sheet should be treated with an etching primer before repainting as mentioned above.

Grant aid

Conservation grants are available for the conservation and repair of protected structures and are administered by the local authorities. You should contact the relevant one for guidance on whether the works you are planning are eligible for a grant and, if so, how to apply. These grants are not available for routine maintenance works, alterations, or improvements nor can grants be given for works already carried out. The type of works must fit within the schedule of priorities set out by the local authority. In order for works to qualify for these grants, they must be carried out in line with good conservation practice. Repair work following the guidance set out in this booklet should be considered as satisfying this requirement.

The Civic Structures Conservation Grant Scheme, administered by the Department of the Environment, Heritage and Local Government, provides grants for the restoration and conservation of buildings in civic ownership or occupation and generally open to the public and which are deemed to be of considerable architectural merit. Applications are accepted from local authorities, civic trusts and other 'not-for-profit' organisations. Further information and application forms are available to download from www.envron.ie.

The Heritage Council provides grants for conservation planning and works. Further information on current schemes and application processes is available from the Council's website: www.heritagecouncil.ie.

Tax incentives are available under Section 482 of the Taxes Consolidation Act 1997 for expenditure incurred on the repair, maintenance, or restoration of certain buildings of significant scientific, historical, architectural or aesthetic interest or gardens of significant horticultural, scientific, historical, architectural, or aesthetic interest. The building or garden must receive a determination from the Revenue Commissioners who must be satisfied that there is reasonable public access to the property. Application forms can be obtained from the Heritage Policy Unit, Department of the Environment, Heritage, and Local Government.

6. New Materials and Technologies

Today many people, including practitioners, aspire to using natural slate but frequently specify blue-black slate or a generic Blue Bangor as the replacement or repair slate. Historical records indicate that over two hundred sites for slate quarries were listed in Ireland in 1840 (though not all were operational at the time) and patterns of use suggest that there was not a predominance of Welsh slate used in areas where transport or access were difficult. This booklet hopes to encourage owners of historic buildings to look more closely at Irish roofs, as it is apparent when travelling through towns and the countryside that there remains an abundance of regional slate and a variety of distinctive details and designs on roofs.



A recently replaced Welsh slate roof (to the left) adjoining a historic one (right), where the difference of character, colour and texture can easily be seen

When the replacement of a roof material becomes necessary, it should be carried out with building materials that match the original as closely as possible. Logically, this would suggest the same species of timber or slates from the original quarry. This may not always be achievable for practical reasons such as cost, availability of material and the operational status of the particular quarry. However, where new materials are to be introduced, they should have been proven to work over a long period of time and should not damage the historic materials of the building, whether by promoting their premature decay or by damaging the character and appearance of the historic building.

It is important to ensure that any new materials introduced into the building comply with all relevant standards or have third party certification as to their suitability, such as Irish Agrément Board (IAB) Certificates.

The use of artificial 'slate'

It is a false economy to remove a natural slate roof from a historic structure and to replace it with a so-called artificial 'slate', which is in fact more properly described as a fibre-cement tile. Not only can it detract from the visual appearance of the building through the generally bland, smooth surface of the tiling, it also works against the long-term conservation of the property. If the building is a protected structure or located in an architectural conservation area, the replacement of natural slate with fibre-cement tile is unlikely to be granted planning permission. The planning authority should be consulted before any works are carried out.

A cost-saving solution sometimes promoted in the past by elements in the construction industry was to re-roof using half natural slate and half cement-fibre tile. The natural slate was retained on the external, more visible, slopes and the artificial tile to the internal roof slopes. This is no longer considered an appropriate approach. The artificial tiles typically deteriorate well in advance of the natural slate on the external slopes. As artificial tile ages it becomes more fibrous, holding water and eventually promoting moss growth along the individual lap of the tile. Its colour can also change and fade in a relatively short period in comparison with natural slate. Replacement fibre-cement tile also tends to be much lighter in weight, resulting in unequal loading of the timber roof structure.

Where artificial tile has been in place for many years, it is likely to have an asbestos content and specialist advice should be sought regarding its removal.

Issues arising from the installation of vapour barriers

There are many different types of modern roof membranes on the market, from sarking felt, which can become brittle over time, to reinforced-plastic roof membranes, which are very strong and will not tear but require high levels of ventilation to ensure that the humidity of the roof space does not reach levels that would make the roof timbers vulnerable to fungal or insect attack.

The breathability of modern roof membrane products varies widely. Many include a fleece backing which can withstand certain levels of condensation and claim to have various levels of 'breathability' (that is, they can allow air to flow through them). Some membranes degrade on exposure to ultraviolet light (sunlight) after as short a period as six weeks and so they cannot be left exposed even in the short term whilst waiting to commence slating. The manufacturers of some of these products recommend that the final metre of roof membrane on the roof near the eaves, projecting into the gutter, be replaced by a reinforced sarking felt or eaves ventilator tray because of the potential for damage from ultraviolet light. However, problems may arise if the air flow around timber rafter ends and wall plates is reduced or restricted, as this is one of the areas where water penetration or condensation is most likely to occur. It should be noted that most of these membranes have two sides and should be laid with the correct side up to function properly. Many modern roof membranes have overlaps indicated with dotted lines to ensure proper laps, and in the future most will come supplied with a long-life sealing tape.

Confusion over whether breathable membranes and ventilation products need to be combined to be effective has prompted many roofers to double up, using counter battens to maintain airflow below the slate or installing roof vents at regular intervals with most breathable membranes. In addition, many suppliers of breathable roof membranes recommend counter-battening to ensure the membrane is not punctured unnecessarily by slate or tile fixings, and to ensure that there is a route for any condensation forming on the back of the slate to drain to the gutter. Counter-battening a roof with the heavier battens that are now standard can raise the plane of a roof and cause detailing difficulties at junctions between adjoining



Example of an in-line slate vent. The vent will not protrude above the roof plane. However, such vents may be unacceptably conspicuous if used on the outward-facing slopes of a roof

roofs or at a closed eaves. These alterations could affect the profile and character of the roof, which is an issue if the building is a protected structure. The architectural conservation officer in the local authority should be consulted when such works are being considered.

Ventilation and insulation

When a slate roof is to be stripped and re-covered, the opportunity to install insulation in the roof space should be considered. At the same time, it is necessary that a healthy level of ventilation in the roof be maintained to ensure that roof timbers remain in good condition. A proprietary ventilation system may need to be introduced to augment ventilation levels. There are many ventilation products on the market that are suitable for conservation work. It is important to carefully select the appropriate product, such as a flush vent slate or partially concealed eaves or ridge vent, which does not detract from the external appearance of the finished roof.



An especially formed lead vent with fly mesh, for use on a church roof. As they are quite distinctive and visible, the use of these vents on a roof where none existed previously should be discussed with the architectural conservation officer in the local authority

The amount of condensation that forms in a roof space will depend on several factors, including the number of occupants, the uses accommodated within the building, the type of heating system, the level of its use and the method of ventilation either installed or naturally occurring. Condensation in the roof space may become an issue when changes occur to the type of use, for example the introduction of residential use or an increase in numbers inhabiting the building. Increased heating levels and the installation of moisture-emitting appliances, such as cookers and showers, will increase moisture levels within a building. In general, most historic buildings with original roofs tend to be well ventilated and the build-up of condensation within the roof space is rarely a problem. Where large numbers of people congregate and/or where an impermeable roof membrane has been laid, condensation can occur at high level within the roof space. The build-up of condensation may be aggravated further by the introduction of higher levels of insulation in the roof space.

To offset condensation problems, additional ventilation may be provided by proprietary in-line slate vents staggered either side of the ridge, as cross-ventilation on the gables of the roof or, if possible, by the use of proprietary eaves vents. However, it is important to ensure that their use does not disturb the form of the roof.

Some contemporary insulation products, such as a layer of foam sprayed onto the underside of the roof rafters, are designed to achieve increased insulation values to the roof space (and to prevent slate slippage). This should not be used in a historic roof, as the foam can cause condensation by reducing through-ventilation of the roof space resulting in serious deterioration in the condition of the roof timbers. A further disadvantage is that slates covered with these foam products are unlikely to be salvageable when it is necessary to strip the roof for re-covering.

There are now insulation products on the market which are hygroscopic in nature; this means that the insulation has an ability to absorb moisture from the air and release it gradually without affecting its insulation properties. The use of this type of insulation product may militate against any problems arising from condensation build-up, but only if it is used with appropriate ventilation. Once again, any new materials introduced into the building must comply with all relevant standards or have third party certification as to their suitability.

The sealing of roof spaces to combat the loss of energy or heat in new buildings is required by the building regulations. Difficulties will arise in attempting to apply these technical interventions to historic roofs, as good air circulation is vital to prevent fungal growth in timber. The provision of appropriate ventilation to historic roof spaces is recommended instead.

For further information on upgrading the thermal efficiency of historic roofs see *Energy Efficiency in Traditional Buildings* in this Advice Series.

Fire safety measures

In terraces or semi-detached buildings, fire safety and insurance requirements may mean that a party wall in the roof space has to be installed where none previously existed. Normally this is achieved by building up the party wall in brickwork and sealing against the underside of the roof plane, or in some cases re-slating to install a firebreak and a discontinuity in the roofing materials. Fire walls can also be created with specialised products which can be draped or hung like a blanket within the roof space. Where structural timber elements are common to both properties it is sometimes proposed to encase them in fire-resistant materials, which can have a visual and material impact. Roof timbers may become susceptible to fungal attack as a result of spray-on treatments.

The build-up of debris and storage items within attic and loft spaces should be avoided, particularly adjoining electrical wiring, transformers or the rear of exposed light fittings. Older wiring in particular should be replaced as, if leaks do occur, sparking can cause fires. Consideration should be given to installing a smoke detector in the attic space as best practice generally and in particular when the attic is used for storage.

Note: the Building Control Acts and associated Regulations apply minimum standards to the design and construction of extensions, alterations and change of use of existing buildings; responsibility for complying with the Building Regulations rests primarily with the owners, designers and builders of buildings or works. In undertaking any works that might have implications for the fire safety of a building or for emergency escape, it will be necessary to follow the advice of a suitably qualified and competent person.

Lightning conductors

The installation of lightning conductors is frequently recommended as part of an overall roof conservation project, as it is an ideal time to conceal the uPVC-covered conducting strips running from the highest point of the chimneystack to the earth. Specialist advice should be sought regarding the need to consider an electrical conductor installation, with reference to the likelihood of a strike based on location, exposure and the topography of the surrounding area. The route of the electrical conductor should be planned as part of the works to a roof. Typically it can be secreted beneath a lead hip or ridge roll, and taken vertically down the external wall behind a downpipe. The high electrical conductivity of copper makes it a good conduit of lightning energy. The typical thickness of copper roofing sheet is usually adequate for lightning protection.

Cabling can be pre-welded onto lead flashings to keep cables out of gutters where they can catch leaves and so cause blockages.

Useful contacts

If the building is a protected structure, the architectural conservation officer in the local authority should be the first person to contact with queries regarding works to it. Other useful contacts include:

Architectural Heritage Advisory Unit, Department of the Environment, Heritage and Local Government,
Custom House, Dublin 1
Telephone: 01 888 2000 Web: www.environ.ie

Building Limes Forum Ireland
Web: www.buildinglimesforumireland.com

Construction Industry Federation, Register of Heritage Contractors,
Construction House, Canal Road, Dublin 6
Telephone: (01) 406 6000 Web: www.cif.ie and www.heritageregistration.ie

Engineers Ireland, 22 Clyde Road, Ballsbridge, Dublin 4
Telephone: 01 665 1300 Web: www.iei.ie

Heritage Council, Áras na hOidhreachta, Church Lane, Kilkenny, Co. Kilkenny
Telephone: (056) 777 0777 Web: www.heritagecouncil.ie

Irish Architectural Archive, 45 Merrion Square, Dublin 2
Telephone: (01) 663 3040 Web: www.iarc.ie

Irish Georgian Society, 74 Merrion Square, Dublin 2
Telephone: (01) 676 7053 Web: www.igs.ie

Royal Institute of the Architects of Ireland, 8 Merrion Square, Dublin 2
Telephone: (01) 676 1703 Web: www.riai.ie

The Society of Chartered Surveyors, 5 Wilton Place, Dublin 2
Telephone: (01) 676 5500 Web: www.scs.ie

Further reading

Ashurst, John; Ashurst, Nicola; Wallis, Geoff and Toner, Dennis. *Practical Building Conservation, Volumes 1-4*. Aldershot: Gower Technical Press Ltd (1988)

Bennet, Frank & Pinion, Alfred. *Roof Slating and Tiling*. First published in 1948. Shaftsbury: Donhead Publishing (2004).

Department of the Environment, Heritage and Local Government. *Architectural Heritage Protection - guidelines for planning authorities*. Dublin: Stationery Office (2004)

Gibney, Arthur. *Studies in Eighteenth Century Building History*. Unpublished doctoral thesis, Trinity College Dublin (1997)

Health and Safety Authority. *Code of Practice for Safety in Roofwork*. Dublin: Health and Safety Authority (2005)

Health and Safety Authority. *Using Ladders Safely*. Dublin: Health and Safety Authority (2007)

Jenkins, Joseph. *The Slate Roof Bible*. Vermont: Chelsea Green Publishing Co. (1997, revised 2003)

Kelleher, Conor and Marnell, Ferdia. *Bat Mitigation Guidelines for Ireland*. Dublin: National Parks and Wildlife Service (2006)

Keohane, Frank, ed. *Period houses – a conservation guidance manual*. Dublin: Dublin Civic Trust (2001)

Lead Sheet Association. *Working with Lead in Construction – a guide to health, safety and environmental care*. Kent: Lead Sheet Association (2009)

Ridout, Brian. *Timber Decay in Buildings – the conservation approach to treatment*. London: E & FN Spon (2000)

Rumley, Peter T J. *Conservation of Decorative Leadwork*. Technical Pamphlet No. 17. London: Society for the Protection of Ancient Buildings (2007)

Rynne, Colin, *Industrial Ireland 1750-1930 – an archaeology*. Cork: The Collins Press (2006)

Williams, Merfyn. *The Slate Industry*. Pembrokeshire: Shire Publications Ltd. (2002)

Glossary

ADZE

A hand-held axe used for cleaning off and preparing timbers. An adze leaves characteristic hewn marks which can be seen on the sides of many historic timbers

APRON FLASHING

The flashing that weathers the lower side of a chimneystack where it rises up through a pitched roof

ARMATURE

A concealed light reinforcement cage, generally for slender elements such as columns or tracery

ASHLAR

Cut stone worked to even faces and right-angled edges and laid in a regular pattern with fine joints

ASSEMBLY MARKS

Incised numerals or symbols, normally made with a knife, chisel or spoon bit, used in prefabricated construction to indicate matching timbers in a frame or truss

BARGEBOARDS

Timber trim to the sloping edges of the verge of a pitched roof; often decoratively carved, pierced, fretted or scrolled, and usually fixed to the end of the purlins

BATTENS

Small sectioned lengths of timber nailed to rafters for slate or tile hanging

BIRDSMOUTH JOINT

A joint in which the end of one timber is cut in a 'v' and rests on the edge of another timber; found particularly between common rafters and wall plates

BRESSUMMER

A large timber lintel over a wide opening such as a fireplace or above a bay window

CEMENT

A binding material mixed with aggregate and water to form a mortar or concrete. The term is usually taken to mean an artificial cement such as Ordinary Portland Cement (OPC)

CHEEK

The vertical side of a dormer window

COLLAR-BEAM ROOF

A timber-framed roof comprising pairs of rafters joined halfway up their length by a horizontal collar tie

COLLAR TIE

A horizontal timber connecting a pair of rafters

COPING

A capping or covering to the top of a wall to prevent water entering the core of the wall

CORBEL

A timber or masonry projection from a wall face, used to support floor or roof beams

COUNTER-BATTENING

Two layers of timber battens fixed at right angles to each other

COUPLE ROOF

A pitched roof consisting of pairs of rafters fixed together at the apex without the presence of a ridge board

CRAMP

A metal strap or pin built into a wall to hold together elements such as adjacent blocks of stone

CRUCK FRAME

Naturally curved tree trunks split to form pointed arch frames spanning from ground to ridge level

CUT ROOF

Any timber roof that is cut on site and not pre-formed. This term was introduced when roofs began to be pre-formed off-site by machine

DAMP-PROOF COURSE OR DPC

An impervious layer built into a wall a little above ground level to prevent rising damp. A dpc can also be used below window sills, above lintels and beneath coping stones to prevent water penetration of the interior of the building

DECKING

Timber boarding or sheeting fixed to the upper faces of the rafters

DORMER

A vertical window in a sloping roof with a roof of its own

EAVES

The lower edge of a sloping roof which overhangs the wall head

FASCIA

A flat vertical board that protects the projecting ends of roof rafters at the eaves and to which the gutter can be fixed

FINIAL

A decorative element placed at the top of a roof, dormer window, ridge, or other portion of a roof. A finial placed on the highest point of a roof is called a terminal

FIRRING

A tapered piece of timber fixed to the top of a rafter or other timber to provide an increased fall across a flat or shallow-pitched roof or in a gutter

FLASHING

A flat sheet of impervious material, usually lead, zinc or copper, covering the junction between materials or elements of a building to prevent water penetration

FLAUNCHING

A sloping mortar fillet, such as around the base of a chimney pot to hold it in place, or on a wall top to throw off rainwater

FLUX

A substance used in soldering which increases the fusibility of metals

GABLE

The area of wall at the end of a pitched roof between the level of the eaves and the apex, usually triangular in shape

HAMMERBEAM

A short transverse timber beam spanning from a bearing wall to the end of a wall bracket and carrying a vertical member which helps to support a principal rafter

HEADLAP

The amount of overlap each roof slate has with the slates two courses below

HIPPED ROOF

A roof which slopes on all four sides, that is without gables

HOPPER HEAD

A receptacle for collecting rainwater from gutters and channelling it into downpipes

JOIST

One of a series of horizontal timbers supporting a floor or carrying a ceiling

LATH

The smallest section of timber used in building; laths can be nailed to the top of rafters as a base for wet roofs, or on the underside to support parging or plasterwork

LIME MORTAR

A mortar made from lime, aggregate and water which, on exposure to air, carbonates and hardens

LINTEL

A small beam made of timber or stone which spans the top of an opening such as a door, window or fireplace and supports the wall above

MERCHANT MARKS

Marks made on timbers when in bulk form by merchants to distinguish their lot of timber. These marks can frequently be found on historic timbers, particularly red deal, and are not to be confused with assembly marks

MORTICE-AND-TENON JOINT

The commonest form of joint between timbers meeting at right angles or oblique angles; the end of one piece is stepped to form a tongue (the tenon) which pierces through a corresponding hole (the mortice) in the other timber

NAIL SICKNESS

The widespread failure of the nails holding roof slates in place

PARAPET

The part of a wall that rises above a roof or terrace

PARGING

The application of lime mortar to the underside of roof finishes

PITCH

The slope of a roof; usually measured in degrees to the horizontal

PURLIN

A horizontal timber running parallel to the ridge and providing support to the common rafters

RAFTER (COMMON)

A sloping timber roof beam running from eaves to ridge and supporting the roof covering

RAFTER (JACK)

A rafter shorter than the full slope from eaves to ridge, typically found at the hipped ends of a roof

RELIGIOUS MARKS

Marks made by a woodman or carpenter on timbers to appease the spirits. Not to be confused with assembly or merchant marks

RENDER

A mixture of a binder (such as lime or cement), an aggregate and water to form a coarse plaster which is applied to the external surfaces of walls

RIDGE

The longitudinal apex of a pitched roof. A ridge piece or board is the longitudinal timber running along the ridge

SARKING

Traditionally, timber boarding fixed above roof rafters, onto which the battens and counter battens were then fixed. The term is now used for any flexible roof underlay, including roofing felt

SCARF JOINT OR SCARFING

A timber joint formed between two sections of timber cut diagonally so that they overlap and typically interlock

SCISSOR BEAM

Two interlocking timbers that cross in the shape of an open pair of scissors, supporting rafters that have a common apex

SHINGLE

A timber roof tile, usually of oak or cedar, sawn or cleft along the grain of the timber. Also used as a wall cladding

SOAKER

A small piece of flashing, approximately the size of a slate or tile, used to seal the joint at a valley or hip or between a pitched roof and an abutting wall such as a gable parapet or a chimneystack

SOFFIT

The underside of any spanning or overhanging part of a building such as the eaves of a roof

SPROCKET

A small timber attached to the upper face of a rafter near its foot to reduce the pitch of the roof over the wall head in order to slow down the flow of rainwater and prevent it overshooting the gutter

TIE BEAM

The bottom horizontal member of a roof truss, or a trussed rafter, tying together the feet of a pair of rafters

TORCHING

See Parging

TRIMMER

A short joist beside an opening in a floor or around a chimneystack in a roof to support the cut ends of the trimmed joists

TRUSS

An arrangement of principal rafters, posts and tie to support the purlins of a roof

TRUSSED RAFTER

A triangulated or trussed component constructed of timbers all set in the same plane. The assemblies are constructed off site and each trussed after it is craned into position, to form a roof of regularly spaced frames with no additional purlins or common rafters. Trussed rafters post-date the mid-twentieth century

UNDERCLOAK

The lowest course of large slate or tile laid first and face-bedded at the eaves or sometimes verge of a roof and subsequently covered by the eaves or verge slates

UNWROUGHT TIMBER

Unworked, or minimally worked, timber that is still in the round with bark attached or is very roughly hewn by a hand-held axe

VERGE

The sloping edge of a pitched roof above the gable

WALL PLATE

A longitudinal timber set square along the top of a wall

WELT

A seam in sheet metal roofing where the edges are folded over and dressed flat. Welts can be single or double depending on the number of folds

WET ROOF CONSTRUCTION

An early form of slate roof construction where the slate was set onto a bed of lime mortar, supported by closely spaced laths fixed to the upper surface of the rafters

The Advice Series is a series of illustrated booklets published by the Architectural Heritage Advisory Unit of the Department of the Environment, Heritage and Local Government. The booklets are designed to guide those responsible for historic buildings on how best to repair and maintain their properties.

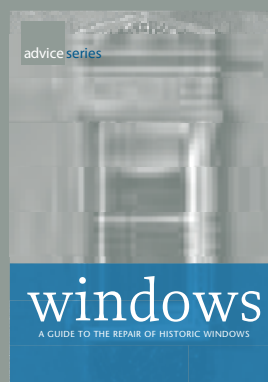
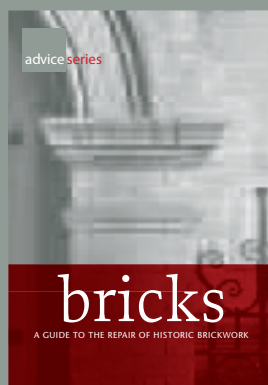
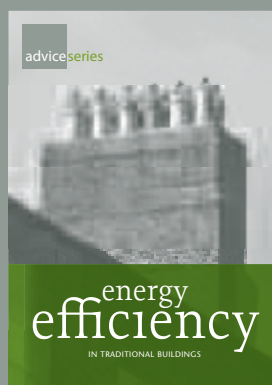

This guide will advise you in caring for your historic roof, helping you to:

- > understand how a traditionally built roof works
- > maintain the roof in good condition
- > recognise when there are problems
- > get the right advice



Comhshaol, Oidhreachta agus Rialtas Áitiúil
Environment, Heritage and Local Government

© Government of Ireland 2010
Price €10

