

Blot's Marvellous Activity Sheet!

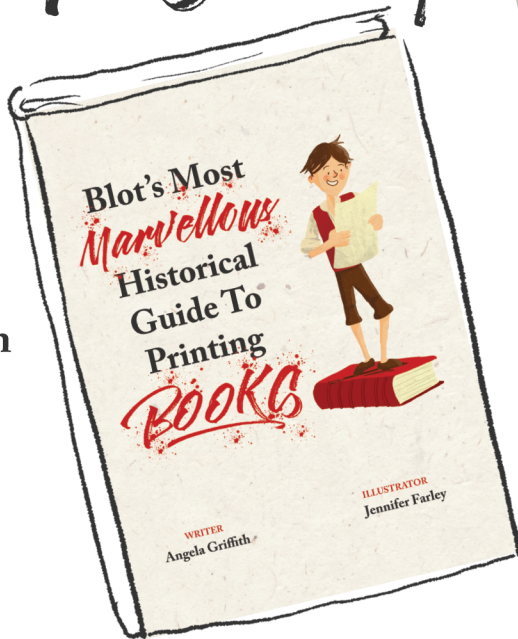

A companion
to this
lovely book!



Draw Blot

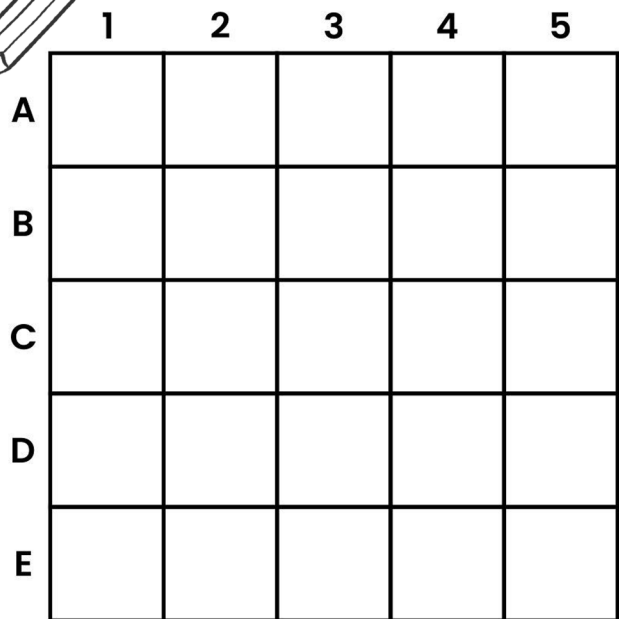
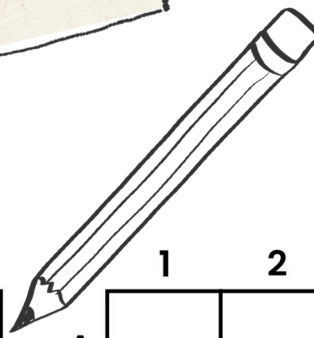
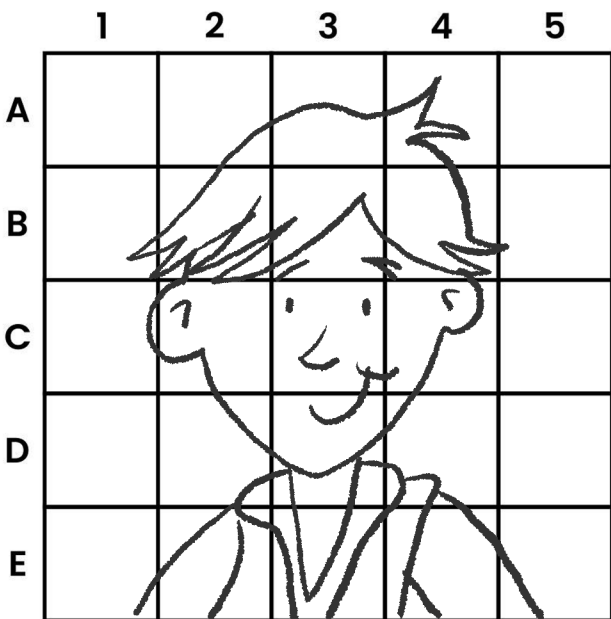

NATIONAL
PRINT MUSEUM
Músaem Náisiúnta Cló

Colour

Which ink colours does the printer use to print Blot? Fill in the blanks below.

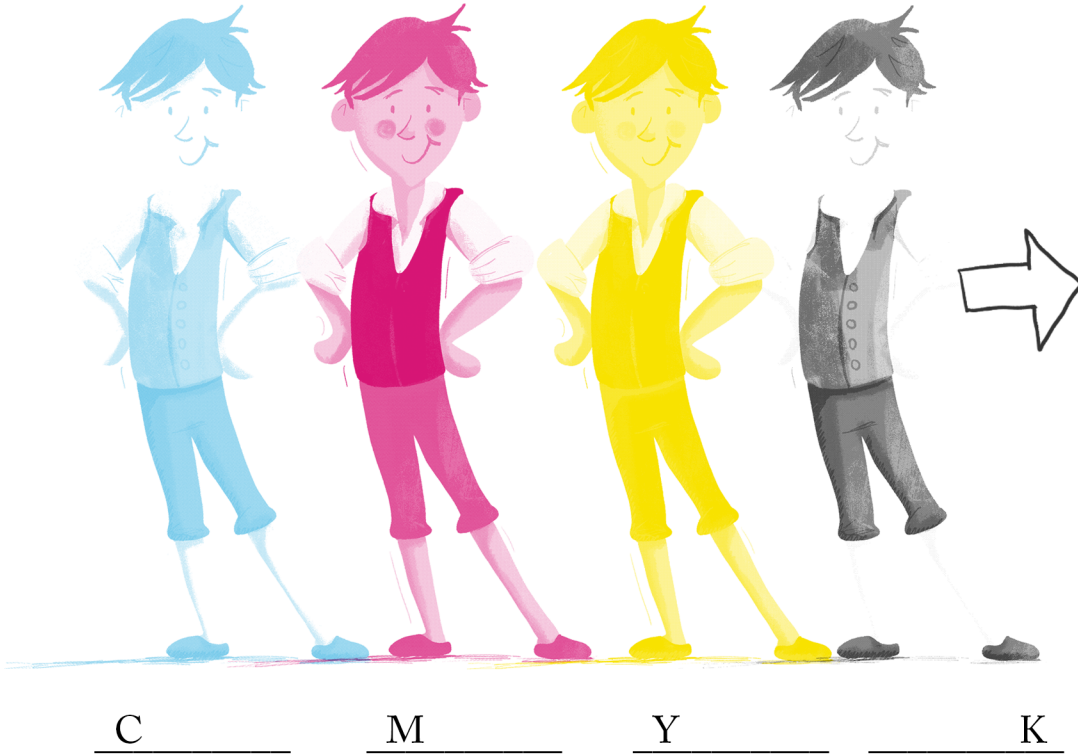

Colour in Blot

Inky Maze

Help Blot find his way to the printing press.

Make sure he doesn't spill any ink, or Mr. Jackson will be very annoyed!

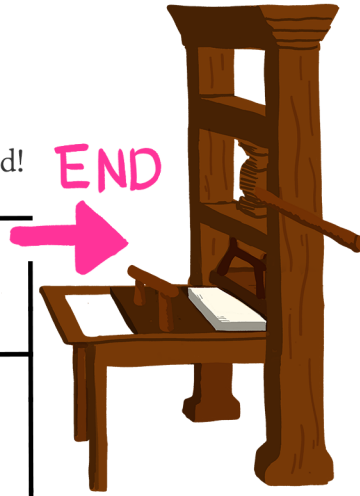
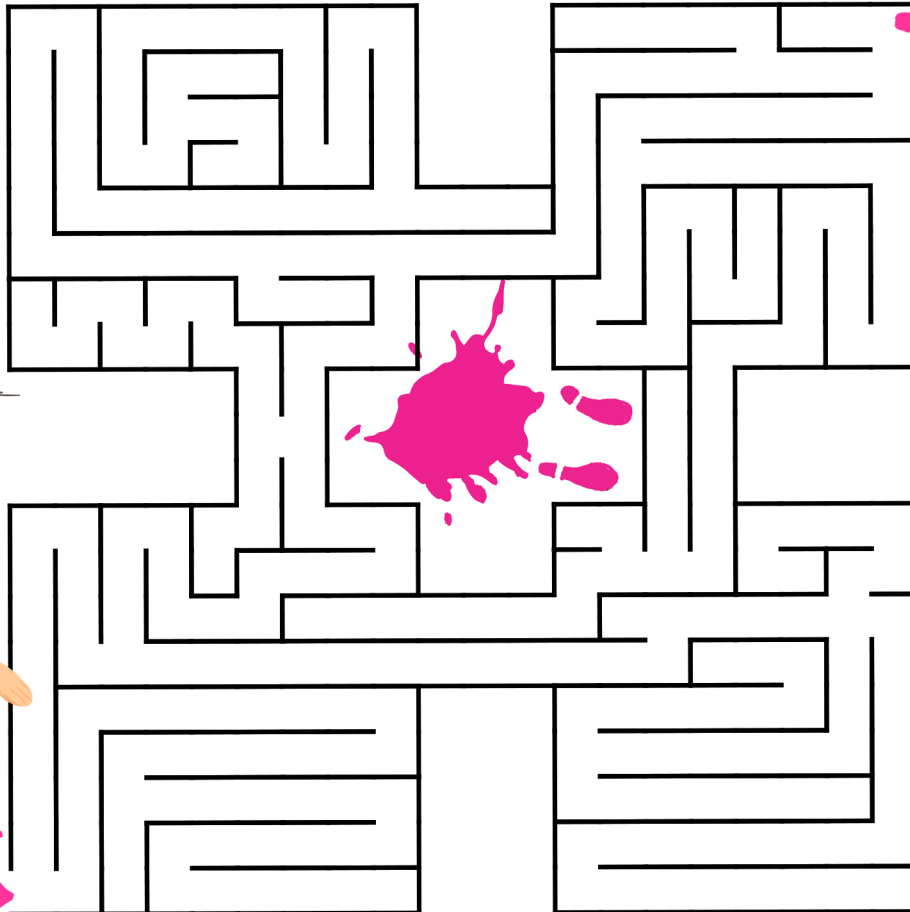

Illuminated Letters

Before the invention of the printing press, books were drawn by hand.

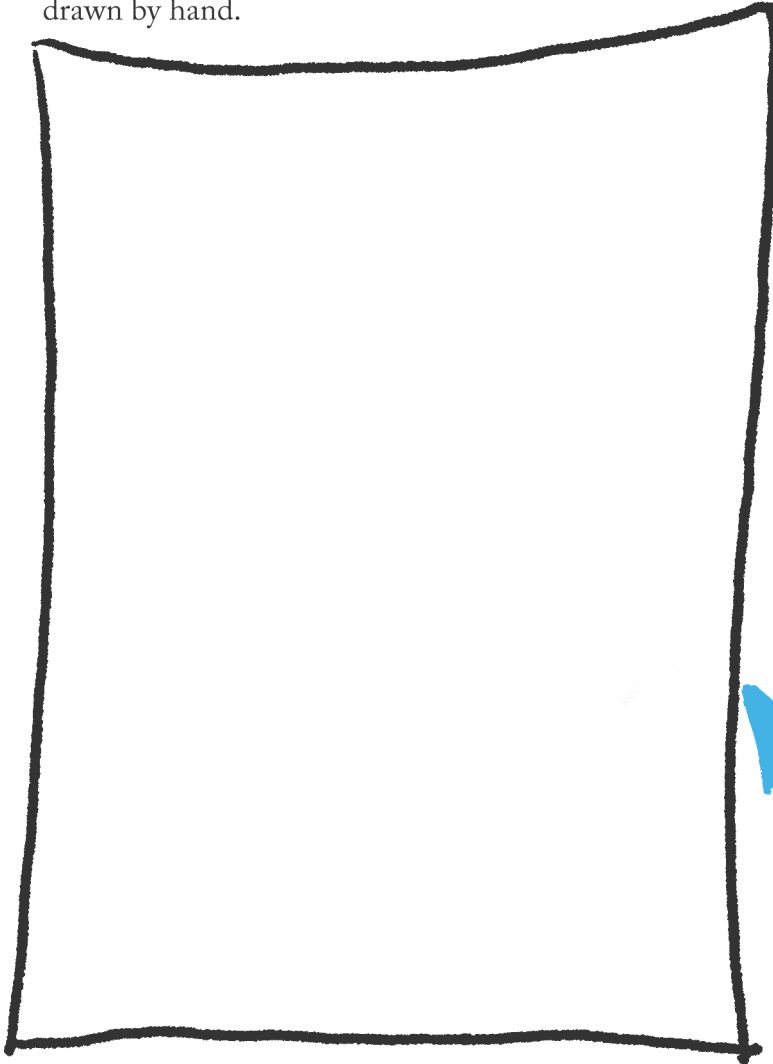
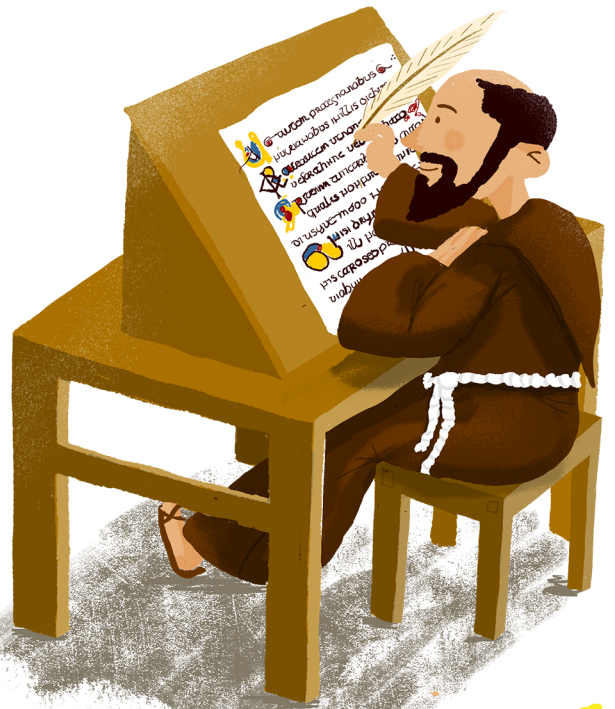

The Book of Kells is a beautiful, richly-decorated illuminated manuscript.

Draw the first letter of your name and decorate it!

Crack The code

Can you work out the three secret words to discover one of the most important inventions ever? Below, there is a KEY that lists all the letters from A- Z . Each of the letters has a corresponding number. Use this KEY to spell out the name of the invention that changed books forever!



A	B	C	D	E	F	G	H	I	J	K	L	M
11	23	4	3	21	13	16	7	15	18	24	1	9

N	O	P	Q	R	S	T	U	V	W	X	Y	Z
26	17	6	14	25	5	2	22	8	10	20	12	19

16 22 2 21 26 23 21 25 16 6 25 15 26 2 15 26 16

6 25 21 5 5

Answer on the back page.

Wordsearch Printing Terms

P	D	G	T	R	R	U	P	S	E	L	T	N	K
N	R	U	L	Q	A	R	O	S	L	P	C	O	E
P	N	T	U	U	O	S	R	E	I	O	E	I	I
A	N	E	B	I	B	E	E	R	M	G	O	T	S
P	O	N	M	L	L	A	C	P	N	N	B	A	C
E	T	B	I	L	R	S	O	G	E	I	C	R	R
R	C	E	O	O	U	S	P	N	P	D	H	O	I
G	O	R	S	N	I	B	D	I	Y	N	A	C	B
C	I	G	A	T	U	O	A	T	T	I	R	E	E
G	N	M	O	A	U	O	U	N	O	B	D	D	E
P	K	R	O	N	A	K	B	I	N	K	B	O	C
S	L	L	O	R	C	S	E	R	I	O	A	E	G
P	R	I	N	T	E	R	R	P	L	O	C	E	I
N	E	T	A	L	P	N	I	O	A	B	K	N	E



- | | |
|-------------|----------------|
| ROLLER | PRINTING PRESS |
| INK | QUILL |
| LINOTYPE | PAPER |
| COMPOSITOR | PLATEN |
| SCRIBE | BOOKS |
| BOOKBINDING | GUTENBERG |
| SCROLLS | PRINTER |
| HARDBACK | MANUSCRIPT |
| DECORATION | DAUBER |



Did you crack the *cryptogram* code?
The answer is:
Gutenberg Printing Press



G U T E N B E R G
16 22 2 21 26 23 21 25 16

P R I N T I N G
6 25 15 26 2 15 26 16

P R E S S
6 25 21 5 5



NATIONAL
PRINT MUSEUM
Músaem Náisiúnta Cló